

DICOM Conformance Statement

Ziehm NetPort

Company Name: Ziehm Imaging GmbH
Product Name: Ziehm NetPort
Devices: Ziehm 8000
Ziehm Vista
Ziehm Vario
Ziehm Vario 3D
Ziehm Vision (2)
Ziehm Vision (2) FD
Ziehm Vision R
Ziehm Vision RFD
Ziehm Vision RFD 3D
Ziehm Solo
Ziehm Solo FD
Ziehm Vision (2) Vario
Ziehm Vision (2) Vario 3D
Ziehm Vision (2) FD Vario
Ziehm Vision (2) FD Vario 3D
Version: 2.039
Completion Date: 2023
Document No.: 282258
Release Date: 2023-12-01

CONFORMANCE STATEMENT OVERVIEW

The product Ziehm NetPort implements the necessary DICOM services to download work lists from an information system, save acquired XA, RF, CR, OT, DX, RTIMAGE and CT images to a network storage device or CD-R, DVD-R, memory stick, print to networked hardcopy device, query patient-, study-, series- and image data and display moved images, inform the information system about the work actually done.

Table A. 1-1 provides an overview of the network services supported by Ziehm Netport:

Table A. 1-1
NETWORK SERVICES

SOP Classes	User of Service (SCU)	Provider of Service (SCP)
Transfer		
Computed Radiography Image Storage	Yes	No
X-ray Angiographic Image Storage	Yes	No
X-ray Radiofluoroscopic Image Storage (only Vision)	Yes	No
Secondary Capture Image Storage	Yes	No
RT Image Storage (Vario 3D and Vision RFD 3D)	Yes	No
Digital X-ray Image Storage for Presentation (only Vario 3D)	Yes	No
CT Image Storage (only Vario 3D and Vision RFD 3D)	Yes	No
X-ray Radiation Dose SR Storage	Yes	No
Workflow		
Modality Worklist	Yes	No
Storage Commitment Push Model	Yes	No
Modality Performed Procedure Step	Yes	No
Query/Retrieve		
Patient Root Q/R Information Model – FIND and MOVE	Yes	No
Study Root Q/R Information Model – FIND and MOVE	Yes	No
Print Management		
Basic Grayscale Print Management	Yes	No
Presentation LUT	Yes	No

Table A. 1-2 provides an overview of the Media Storage Application Profiles supported by Ziehm NetPort:

Table A. 1-2
MEDIA SERVICES

Media Storage Application Profile	Write Files (FSC or FSU)	Read Files (FSR)
General Purpose CD-R	Yes	Yes
Magneto Optical Disk (only DOS)	Yes	Yes
Floppy (only DOS)	Yes	Yes
General Purpose USB	Yes	Yes
General Purpose DVD	Yes	Yes

A.1 TABLE OF CONTENTS

CONFORMANCE STATEMENT OVERVIEW.....	3
A.1 TABLE OF CONTENTS.....	4
A.2 GENERAL	7
A.2.1 REVISION HISTORY	7
A.2.2 AUDIENCE.....	10
A.2.3 REMARKS	10
A.2.4 DEFINITIONS, TERMS AND ABBREVIATIONS	11
A.2.5 REFERENCES.....	11
A.3 NETWORKING.....	12
A.3.1 IMPLEMENTATION MODEL	12
A.3.1.1 Application Data Flow	12
A.3.1.2 Functional Definition of Ziehm NetPort AE	13
A.3.1.2.1 Ziehm NetPort as a Storage Application Entity	13
A.3.1.2.2 Ziehm NetPort as a Query/Retrieve Application Entity.....	13
A.3.1.2.3 Ziehm NetPort as a Worklist and MPPS Application Entity.....	13
A.3.1.2.4 Ziehm NetPort as a Print Application Entity.....	13
A.3.1.3 Sequencing of Real-World Activities.....	14
A.3.2 AE SPECIFICATIONS	15
A.3.2.1 Storage Application Entity Specification	15
A.3.2.1.1 SOP Classes.....	15
A.3.2.1.2 Association Policies	15
A.3.2.1.2.1 General.....	15
A.3.2.1.2.2 Number of Associations	15
A.3.2.1.2.3 Asynchronous Nature.....	15
A.3.2.1.2.4 Implementation Identifying Information	15
A.3.2.1.3 Association Initiation by Real-World Activity.....	15
A.3.2.1.3.1 Activity – Net Store, DICOM Store, NetCommit, DICOM Commit	15
A.3.2.1.3.1.1 Sequencing of Activities	16
A.3.2.1.3.1.2 Proposed Presentation Contexts.....	17
A.3.2.1.3.1.3 SOP Specific Conformance DX and CT Image Storage on 3D devices ..	17
A.3.2.1.3.1.4 Behavior of SCU in response to C_STORE_RSP Status	17
A.3.2.1.3.1.5 SOP Specific Conformance for Storage Commitment SOP Class.....	18
A.3.2.1.3.1.5.1 Storage Commitment Operations (N-ACTION)	18
A.3.2.1.3.1.5.2 Behavior of SCU in response to N_EVENT_REPORT_RQ Status...	18
A.3.2.2 Query/Retrieve Application Entity Specification	18
A.3.2.2.1 SOP Classes.....	18
A.3.2.2.2 Association Policies (see A.3.2.1.2)	18
A.3.2.2.3 Association Initiation Policy	19
A.3.2.2.3.1 Activity – Query/Retrieve.....	19
A.3.2.2.3.1.1 Description and Sequencing of Activities	19
A.3.2.2.3.1.2 Proposed Presentation Contexts.....	20
A.3.2.2.3.1.3 SOP Specific Conformance for Query/Retrieve	20
A.3.2.2.4 Accepted SOP Storage Classes for Image Retrieve	22
A.3.2.3 Workflow Application Entity Specification	23
A.3.2.3.1 SOP Classes.....	23
A.3.2.3.2 Association Policies (see A.3.2.1.2)	23
A.3.2.3.3 Association Initiation Policy	24
A.3.2.3.3.1 Activity – Worklist	24
A.3.2.3.3.1.1 Description and Sequencing of Activities	24
A.3.2.3.3.1.2 Proposed Presentation Contexts.....	25
A.3.2.3.3.1.3 SOP Specific Conformance Statement	25
A.3.2.3.3.2 Activity – MPPS.....	27
A.3.2.3.3.2.1 Description and Sequencing of Activities	27
A.3.2.3.3.2.2 Proposed Presentation Contexts.....	28
A.3.2.3.3.2.3 SOP Specific Conformance for MPPS	28
A.3.2.3.4 Association Acceptance Policy	30
A.3.2.4 Print Management Application Entity Specification	30

A.3.2.4.1	SOP Classes	30
A.3.2.4.2	Association Policies (see A.3.2.1.2)	31
A.3.2.4.3	Association Initiation Policy	31
A.3.2.4.3.1	Activity – DICOM Print	31
A.3.2.4.3.1.1	Description and Sequencing of Activities	31
A.3.2.4.3.1.2	Proposed Presentation Contexts	32
A.3.2.4.3.1.3	SOP Specific Conformance all Print Management SOP Classes.....	32
A.3.2.4.3.1.3.1	Printer SOP Class Operation (N-Get).....	32
A.3.2.4.3.1.3.2	Film Session SOP Class Operations.....	33
A.3.2.4.3.1.3.3	Basic Film Box SOP Class Operations.....	33
A.3.2.4.3.1.3.4	Basic Grayscale Image Box SOP Class Operation (N-SET)	34
A.3.2.4.3.1.3.5	Presentation LUT SOP Class Operations	34
A.3.2.4.4	Association Acceptance Policy.....	35
A.3.3	NETWORK INTERFACES.....	35
A.3.3.1	Physical Network Interface	35
A.3.3.2	Additional Protocols.....	35
A.3.4	CONFIGURATION.....	36
A.3.4.1	AE Title/Presentation Address Mapping.....	36
A.3.4.1.1	Local AE Title(s) and Port(s)	36
A.3.4.1.2	Remote AE Titles and Ports	36
A.3.4.1.2.1	Storage and Storage Commitment SCP AE Titles and Ports.....	37
A.3.4.1.2.2	Query/Retrieve SCP AE Titles and Ports	39
A.3.4.1.2.3	Worklist and MPPS SCP AE Titles and Ports.....	39
A.3.4.1.2.4	Print SCP AE Titles and Ports	40
A.3.4.2	Configuration Files.....	41
A.4	MEDIA INTERCHANGE.....	42
A.4.1	IMPLEMENTATION MODEL	42
A.4.1.1	Application Data Flow.....	42
A.4.1.2	Functional Definition of AEs	42
A.4.1.2.1	Functional Definition of Offline-Media Application Entity.....	42
A.4.1.3	Sequencing of Real-World Activities	42
A.4.1.4	File Meta Information Options	42
A.4.2	AE SPECIFICATION.....	43
A.4.2.1	Offline-Media Application Entity Specification	43
A.4.2.1.1	File Meta Information for the Application Entity.....	43
A.4.2.1.2	Real World Activities.....	43
A.4.2.1.2.1	Activity – Export to Medium and Import from Medium.....	43
A.4.2.1.2.1.1	Media Storage Application Profiles	43
A.4.2.1.2.1.1.1	Options	44
A.4.3	AUGMENTED AND PRIVATE APPLICATION PROFILES.....	44
A.4.4	MEDIA CONFIGURATION	44
A.5	SUPPORT OF CHARACTER SETS	45
A.6	SECURITY	46
A.7	ANNEXES.....	46
A.7.1	IOD CONTENTS.....	46
A.7.1.1	Created SOP Instances.....	46
A.7.1.1.1	X-ray Angiographic Image IOD	46
A.7.1.1.2	Computed Radiography Image IOD	47
A.7.1.1.3	Secondary Capture Image IOD	47
A.7.1.1.4	Digital X-ray Image IOD.....	47
A.7.1.1.5	COMPUTED TOMOGRAPHY Image IOD	48
A.7.1.1.6	RT Image IOD	48
A.7.1.1.7	X-ray Radiation Dose SR IOD.....	48
A.7.1.1.8	Common Modules	49
A.7.1.1.8.1	Attributes of DICOMDIR.....	65
A.7.1.1.8.2	Example README.TXT (Vision until SW 5.30)	66
Storage Commitment Request N-ACTION Information	66	
A.7.2	DATA DICTIONARY OF PRIVATE ATTRIBUTES (FOR VARIO 3D).....	67
A.7.3	DATA DICTIONARY OF PRIVATE ATTRIBUTES (AS FROM SW 6.04)	67
A.7.3.1	Private Tags provided by RFD 3D.....	71

A.7.4	ZIEHM NAVIPORT 2D	72
A.7.4.1	Configuration.....	72
A.7.4.2	Navigation Flag.....	72
A.7.4.3	Behavior.....	72
A.7.4.4	Form of UDP messages	72
A.8	IHE INTEGRATION STATEMENT	73

A.2 GENERAL

A.2.1 REVISION HISTORY

Document Version	Date of Issue	Author	Description
SW11-SW14	before 2000	Stahl	Storage released Query Patient-Level released
SW 15ff.	Jan-Aug 2000	Rotermund	Worklist released ISO IR 100 completed new Instance UID
SW 16	Oct 2000	Rotermund	Verification released Basic Print released
SW 17ff.	2001	Rotermund	XA-Multiframe released Media Storage released
SW 18	2001	Rotermund	CD-ROM
SW 19	Jul 2001	Rotermund	Query/Retrieve all levels and model MOVE
SW 20ff.	Aug 2002-Feb 2004	Rotermund	Storage Commitment released MPPS released
SW 21ff.	Jun 2004	Rotermund	common version with Vision
SW 22	Jan 2005	Rotermund	CD on Vario3D new chapter Security
2.0	May 30, 2005	Rotermund	SW 4.12 Vision released Conformance Statement completely reviewed with DICOM 3.2 –2004
2.001	July 14, 2005	Rotermund	FSR for Vision SW 4.14 Export single images Vario3D
2.002	August 18, 2005	Rotermund	Vision Flat SW 4.15: Collimator RECTANGLE Vista SW 22.002: Worklist matching keys
2.003	December 05, 2005	Rotermund	Tag 0018,1500 (cine) Tag 0018,115E in Gydm ² Ziehm Media Viewer on Vision/Vario3D
2.004	March 01, 2006	Rotermund	IHE Integration Profiles Scheduled Workflow Actor: Acquisition Modality (Vision only) Portable Data for Imaging Actor: Portable Media Creator (Vision only)
2.005	January 30, 2007	Rotermund	Description Ziehm NaviPort IHE Integration Statement SW 5.03 Vision SW 22.003 DOS = SW 1.01 Linux SW 1.03 V2-0.5K SW 22.004 only bug elimination
2.006	September 10, 2007	Rotermund Heuss	SW 5.05 Vision Family - UIDs new mechanism SW 1.04/2.01 Vista Family Revised by technical writer
2.007	April 30, 2008	Rotermund	SW 5.16 Vision Family IHE Profile Patient Information Reconciliation MPPS Append updated Storage Commitment updated RF Image Storage SW 1.05 Vista Step1 Workaround for "E93" time synchronization

Document Version	Date of Issue	Author	Description
2.008	August 27, 2008	Heckmann Haußner	Added Vision RFD
2.009	September 30, 2008	Haußner	Added Ziehm Solo
2.010	November 20, 2008	Rotermund Haußner	DICOM by merge added Deleted Ziehm Solo Changed Ziehm Vision Vario/3D (FD) SW1.09 Changed Ziehm Vision ² Vario/3D (FD) SW1.09
2.011	November 21, 2008	Rotermund Haußner	Added Ziehm Solo Vision SW 5.20 RT Image DICOM Multiframe restricted DICOM Print and Worklist Configuration Changed SW 5.20 -> SW 5.22
2.012	February 11, 2009	Rotermund	SW 2.04 Ziehm Vista ÄA: A/08/189
2.013	May 20, 2009	Rotermund	Vision without merge-lib
2.014	October 6, 2009	Rotermund	SW 5.25 Ziehm Vision More than 1 navigation server WLAN
2.015	October 29, 2009	Rotermund	Ziehm 8000 (7000 Plus) without merge-lib ÄA: A2.05/09/145 Ziehm Vista is out of production
2.016	December 16, 2009	Rotermund	SW 5.28 for Ziehm Solo Acquisition Date/Time contra Content Date/Time Update RTImage Modality OT for Storage and Worklist
2.017	June 29, 2010	Rotermund	SW 5.28.3 for all Visions Improvements Image Retrieve Patient Position
2.018	March 14, 2011	Rotermund	SW 5.30.0 for Ziehm Vision FD, RFD Smart Vascular RoboC SW 5.62.0 Worklist data synchronization of Study Instance UID, Requested Procedure ID/Description Scheduled Procedure Step ID/Description Referring Physician's Family Name DICOM Image header with Image Area Dose Product Exposure Time DNS and DHCP Storage Commitment revision Termination of storescp by termscu and private Shutdown SOP Class
2.019	July 19, 2011	Rotermund	SW 2.06 for Ziehm 8000, Ziehm Vista: Data consistency between MWL and image header Default windowing
2.020	September 14, 2011	Haußner	SW 5.30.1 for Ziehm Vision R, FD, RFD SW 5.30.1 for Ziehm Vision ² (FD) SW 5.30.1 for Ziehm Vision Vario/3D (FD) SW 5.30.1 for Ziehm Vision ² Vario/3D (FD) SW 5.30.1 for Ziehm Solo

Document Version	Date of Issue	Author	Description
2.021	June 15, 2012	Rotermund	SW 5.30.3 for Ziehm Vision R, FD, RFD SW 5.30.3 for Ziehm Vision ² (FD) SW 5.30.3 for Ziehm Vision Vario/3D (FD) SW 5.30.3 for Ziehm Vision ² Vario/3D (FD) SW 5.30.3 for Ziehm Solo Multisession for DICOM CDRUM, DVDs Exposure Time with net/gross time UDP DICOM Echo on user level with message
2.022	November 15, 2012	Rotermund	X-ray Radiation Dose SR = IHE Profile REM (Radiation Exposure Monitoring)
2.023	July 09, 2013	Rotermund	Pixel-Spacing for measurement images Display Shutter
2.024	November 14, 2013	Rotermund	SW 6.04 (NGP) for Ziehm Vision RFD Without X-ray Radiation Dose SR and SNTP Data Dictionary of Private Attributes + Table A.7.1-44 added
2.025	September 17, 2014	Krebs	SW 6.05 for Ziehm Vision RFD SW 6.05 SP1 for Ziehm Vision RFD 3D
2.026	April 15, 2015	Rotermund	SW 6.06
2.027	August 06, 2015	Rotermund	SW 7.00 X-ray Radiation Dose SR implemented
2.028	February 01, 2016	Rotermund	Added Ziehm Solo FD Device list without SW-Versions WLAN without product names Minor corrections
2.029	January 01, 2018	Rotermund	SW 2.13 X-ray Radiation Dose SR for Ziehm 8000 SW 7.04 Fujifilm devices
2.030	October 01, 2018	Rotermund	SW 7.06 Fujifilm devices in separate document Image Pixel are exported with DICOM LUT IHE Profile: Consistent Time added List of private tags updated
2.031	November 19, 2019	Rotermund	SW 7.07 Brachytherapy images Limitation of client ports Corrections
2.032	April 1, 2020	Rotermund	DIN 6862-2:2011-12 requirements
2.033	July 1, 2021	Rotermund	SW 7.06.7 / 7.07.3 Improvements X-ray Radiation Dose SR Configuration of VPN Server and Open Web Socket Protocol (Remote Service)
2.034	Jan 1, 2022	Rotermund	SW 7.06.10 / 7.07.6 Additional improvements X-ray Radiation Dose SR, i.e. add 0040,A370 – sequence
2.035	Mar 27, 2023	Grolleau	SW 7.08 Add concept name EV (113737, DCM, "Distance Source to Reference Point") to X-ray Radiation Dose SR TID 10007 New DCMTK version
2.036	Apr 21, 2023	Grolleau	SW 7.09 Workflow for retrieved Endosize instances forwarded to the embedded Endonaut server
2.037	Sep 18, 2023	Grolleau	Add new value for Implementation Version Name. Remove unnecessary dcmtk version from Configuration file. (software doesn't use any dcmtk configuration file)

Document Version	Date of Issue	Author	Description
2.038	Nov 8, 2023	Grolleau	SW 7.10 Add XA Position module Improve implementation details for Specific Character set used in the different supported IODs Change source of dose information for RDSR
2.039	Dec 12, 2023	Grolleau	Replace occurrences of 7.10 by 7.08.1

A.2.2 AUDIENCE

This document is intended for hospital staff, health system integrators, software designers or implementers. It is assumed that the reader has a working understanding of DICOM.

A.2.3 REMARKS

DICOM, by itself, does not guarantee interoperability. However, the Conformance Statement facilitates a first-level validation for interoperability between different applications supporting the same DICOM functionality.

In more than a decade the Ziehm Netport has gained experience in successful interconnectivity with other vendors' medical equipment.

For the benefit of readability, the product name "Vision" will be used for all systems "Ziehm Vision (2)", "Ziehm Vision R", "Ziehm Vision (2) FD", "Ziehm Vision RFD", "Ziehm Vision (2) Vario", "Ziehm Vision (2) Vario 3D", "Ziehm Vision (2) FD Vario", "Ziehm Vision (2) FD Vario 3D", "Ziehm Vision RFD 3D", "Ziehm Solo" and "Ziehm Solo FD" throughout this document.

This product uses the OFFIS DICOM Toolkit DCMTK © 1993–2017 OFFIS e.V., Oldenburg Germany.

A.2.4 DEFINITIONS, TERMS AND ABBREVIATIONS

Definitions, terms and abbreviations used in this document are defined within the different parts of the DICOM standard.

Abbreviations and terms are as follows

AE	DICOM Application Entity
AET	Application Entity Title
CD-R	Compact Disk Recordable
DICOM	Digital Imaging and Communications in Medicine
DOS	MS-DOS operating system
DVD-R	Digital Versatile Disk Recordable
FSC	File Set Creator
FSU	File Set Updater
FSR	File Set Reader
IHE	Integrating the Healthcare in Enterprises
IOD	(DICOM) Information Object Definition
ISO	International Standard Organization
MPPS	Modality Performed Procedure Step
MSPS	Modality Scheduled Procedure Step
R	Required Key Attribute
O	Optional Key Attribute
PACS	Picture Archiving and Communication System
PDU	(DICOM) Protocol Data Unit
SCU	(DICOM) Service Class User (= DICOM Client)
SCP	(DICOM) Service Class Provider (= DICOM server)
SOP	(DICOM) Service Object Pair
RIS	Radiology Information System
UID	unique identifier
VR	Value Representation
SR	Structured Report

A.2.5 REFERENCES

DICOM Standard, NEMA PS 3.1-3.21, 2018c, www.dicomstandard.org/current/
MergeCom-3 Library Linux Version 3.30 IB25, www.merge.com
DCMTK Version 3.6.7 for SW Version 7.08 and above,
DCMTK Version 3.5.4, 3.6.0 and 3.6.1, dicom.offis.de

A.3 NETWORKING

A.3.1 IMPLEMENTATION MODEL

A.3.1.1 Application Data Flow

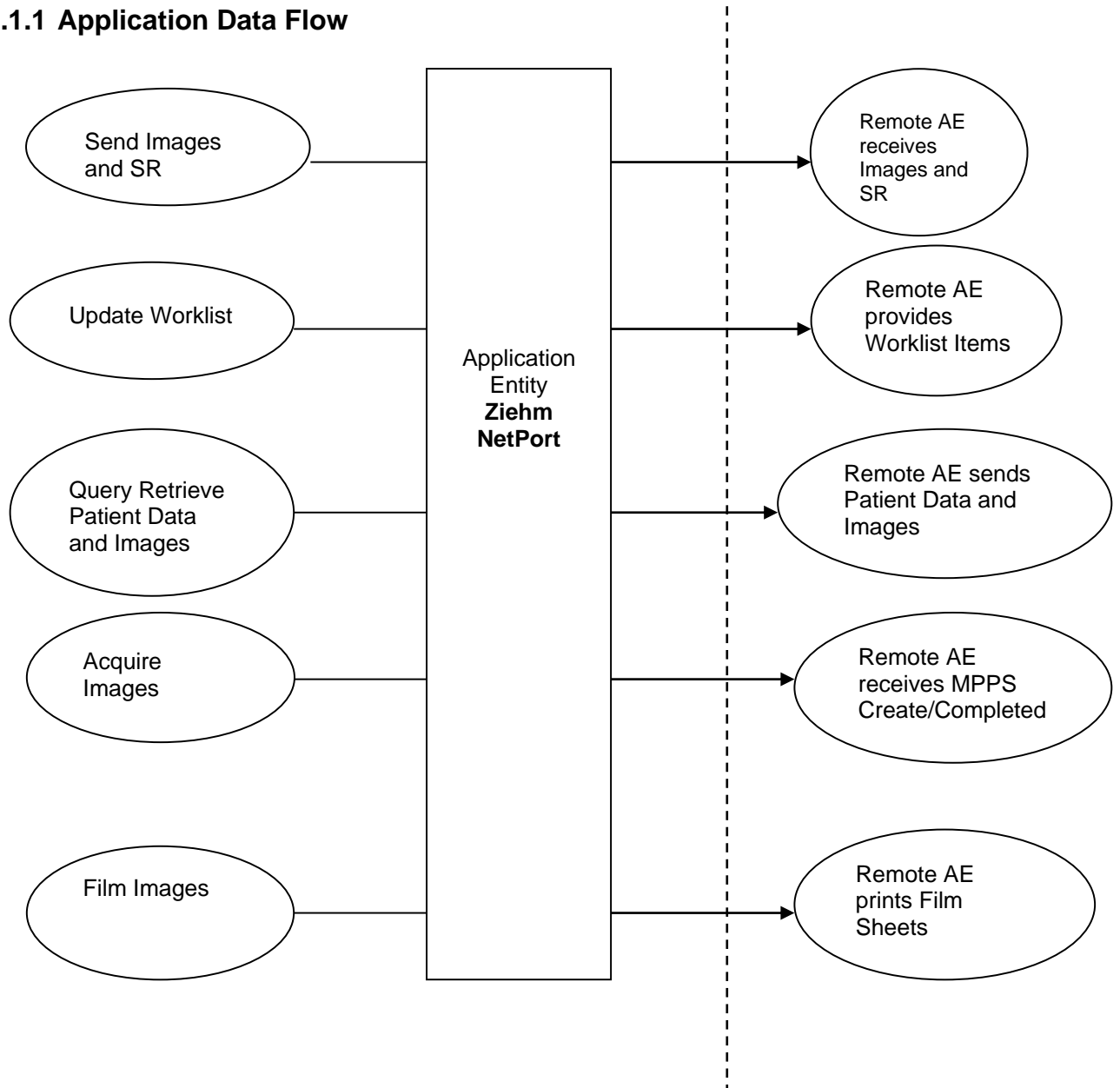

DICOM Standard Interface
Figure A.3.1-1

APPLICATION DATA FLOW DIAGRAM

The Ziehm NetPort Application Entity sends images and structured report to a remote AE, receives Worklist information from and sends MPPS information to a remote AE, queries Patient Data and Images (IM.) from a remote AE and displays images, prints images on a remote AE.

A.3.1.2 Functional Definition of Ziehm NetPort AE

A.3.1.2.1 Ziehm NetPort as a Storage Application Entity

The Ziehm NetPort AE is a SCU that is responsible for sending digital images and structured reports from the Ziehm C-arm to a Storage SCP. Upon successful negotiation of a Presentation Context the image and structured report transfer is started. If the association cannot be opened, the Ziehm NetPort displays an error message except when sending the dose report automatically (Ziehm format and DICOM SR). The user can send single images, multiframe images, also single images from a multiframe (Vision creates a new multiframe), a set of marked images, a whole patient folder or a set of patient folders (only Vision). If the Storage SCP is configured as an archive device Ziehm NetPort AE will request Storage Commitment for the transferred images and if a commitment is successfully obtained it will record this information in the local database.-

Maximum size of Multiframe is ca. 600 MBytes, with SW 6.00 and higher ca. 1,2 GBytes.

A.3.1.2.2 Ziehm NetPort as a Query/Retrieve Application Entity

The Ziehm NetPort AE is a SCU that is responsible for querying patient data, study data, series data, image data and retrieving and displaying images from Query SCP. The Ziehm NetPort AE is able to retrieve single images or a complete series from 2 up to 5 (Vision) other SCPs. The Association Negotiation works as specified in A.4.1.2.1.

A.3.1.2.3 Ziehm NetPort as a Worklist and MPPS Application Entity

The Ziehm NetPort AE is a SCU that is responsible for downloading a Worklist from a Worklist SCP. The results will be displayed in a list, where the user can select an item which is automatically saved in the local database. If MPPS is activated the Ziehm NetPort AE sends a MPPS Create to the MPPS SCP. An existing patient can be overwritten by worklist data (Vision). With MPPS Completed an X-ray Radiation Dose SR is sent to Storage SCP.

A.3.1.2.4 Ziehm NetPort as a Print Application Entity

The Ziehm NetPort AE is a SCU that is responsible printing digital images from the Ziehm C-arm to a Print SCP. An Association is established with the printer and the printer's status is determined. If the printer is operating normally, the Ziehm NetPort AE sends the print job, otherwise an error message will be displayed.

A.3.1.3 Sequencing of Real-World Activities

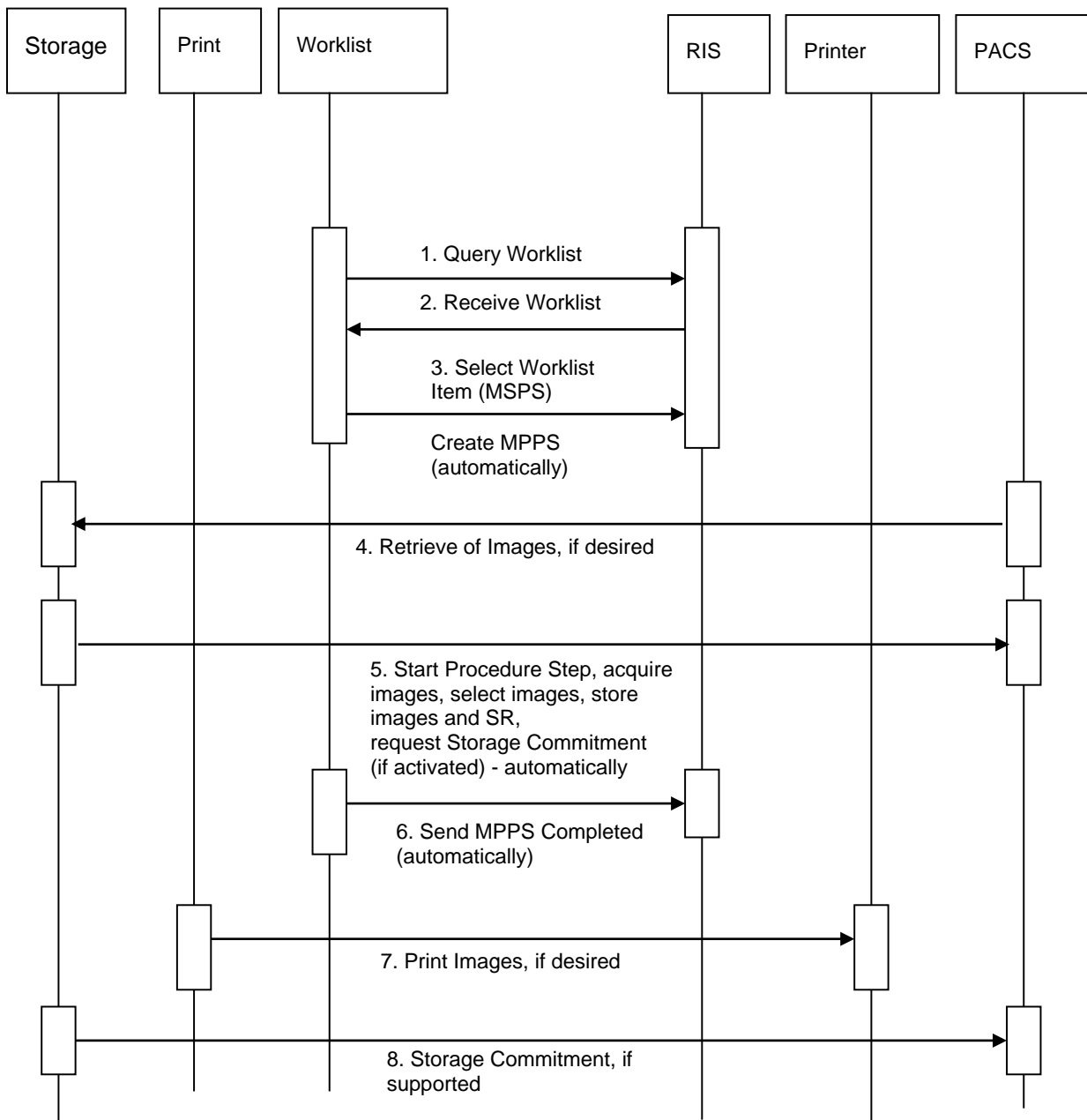

Figure A.3.1-2
SEQUENCING CONSTRAINTS

Under normal scheduled workflow conditions the sequencing constraints illustrated in Figure A.3.1-2 apply:

1. Query Worklist (if configured send unspent dose reports)
2. Receive Worklist
3. Select Worklist Item, Send MPPS Create (automatically, if activated)
4. If desired: retrieve former images of selected patient from PACS
5. Start procedure step, acquire image, store images and structured report (if MPPS is deactivated)
6. Send N_ACTION for Commitment
7. Send MPPS Completed (automatically, if activated) and structured report to PACS
8. Print images if desired
9. Ask Storage Commitment

A.3.2 AE SPECIFICATIONS

A.3.2.1 Storage Application Entity Specification

A.3.2.1.1 SOP Classes

The Ziehm NetPort AE provides Standard Conformance to the following SOP Classes:

Table A.3.2-1

SOP CLASSES FOR AE STORAGE

SOP Class Name	SOP Class UID	SCU	SCP
Computed Radiography Image Storage	1.2.840.10008.5.1.4.1.1.1	Yes	No
X-ray Angiographic Image Storage	1.2.840.10008.5.1.4.1.1.12.1	Yes	No
X-ray Radiofluoroscopic Image Storage (only Vision)	1.2.840.10008.5.1.4.1.1.12.2	Yes	No
Secondary Capture Image Storage	1.2.840.10008.5.1.4.1.1.1.7	Yes	No
RT Image Storage (only Vision)	1.2.840.10008.5.1.4.1.1.481.1	Yes	No
Digital X-ray Image Storage for Presentation (only VARIO 3D)	1.2.840.10008.5.1.4.1.1.1.1	Yes	No
CT Image Storage (only VARIO 3D and RFD 3D)	1.2.840.10008.5.1.4.1.1.2	Yes	No
X-ray Radiation Dose SR Storage	1.2.840.10008.5.1.4.88.67	Yes	No
Storage Commitment Push Model (not VARIO 3D workstation)	1.2.840.10008.1.20.1	Yes	No
Verification	1.2.840.10008.1.1	Yes	No

A.3.2.1.2 Association Policies

A.3.2.1.2.1 General

The DICOM standard application context name for DICOM 3.0 is always proposed:

Table A.3.2-2

DICOM APPLICATION CONTEXT FOR AE STORAGE

Application Context Name	1.2.840.10008.3.1.1.1
--------------------------	-----------------------

A.3.2.1.2.2 Number of Associations

Ziehm NetPort initiates one Association at a time for each destination to which a transfer request is being processed. Ziehm NetPort initiates and accepts only one association establishment at a time.

A.3.2.1.2.3 Asynchronous Nature

Multiple outstanding transactions are not supported.

A.3.2.1.2.4 Implementation Identifying Information

Table A.3.2-3

DICOM IMPLEMENTATION CLASS AND VERSION FOR AE STORAGE

Implementation Class UID (Ziehm ROOT_UID)	2.16.840.1.113669.632.6.1
Implementation Version Name	OFFIS_DCMTK_354, OFFIS_DCMTK_361, OFFIS_DCMTK_367

A.3.2.1.3 Association Initiation by Real-World Activity

A.3.2.1.3.1 Activity – Net Store, DICOM Store, NetCommit, DICOM Commit

The user of the Ziehm 8000, Ziehm 7000 PLUS, Ziehm Vista, Ziehm Vista PLUS, Ziehm Vario3D selects one or more images on the appliance and presses the "Net Store" key. On Ziehm Vision the user can also select a whole patient folder or a set of folders and then press the DICOM Store button. The X-ray Radiation Dose SR will be sent automatically with the Ziehm Dose Image (until SW 5.30 marked by X) or – if MPPS is activated – with the MPPS Completed or if configured in a Dose server accordingly.

A.3.2.1.3.1.1 Sequencing of Activities

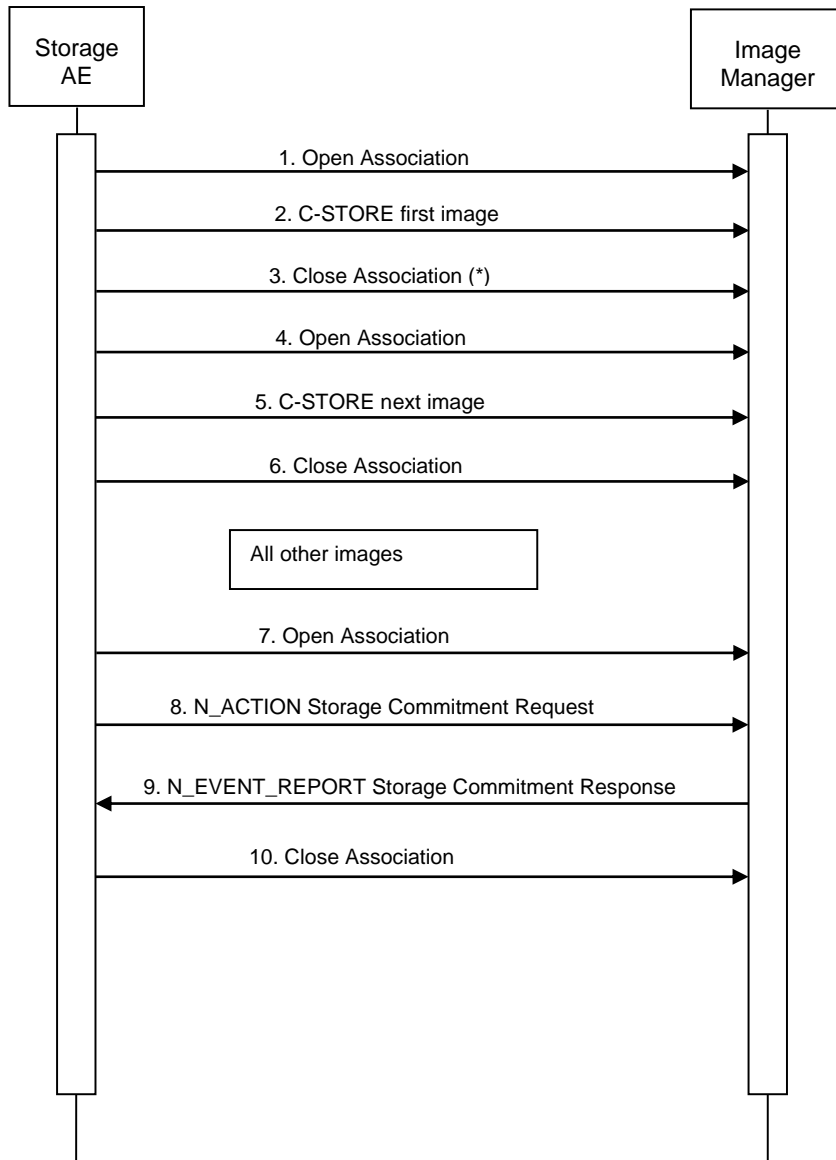

Figure A.3.2-4
**SEQUENCING OF ACTIVITY –
 Net Store, DICOM Store, NetCommit, DICOM Commit**

Ad 9. Ziehm Vision AE waits asynchronously for N_EVENT_REPORT Ad (*) as configured 7-10. Are executed after each DICOM Store

A.3.2.1.3.1.2 Proposed Presentation Contexts

Each time an association is initiated, the Ziehm NetPort proposes one single Presentation Context to be used on that association.

Table A.3.2-5

Proposed Presentation Contexts for Real-World Activity NetStore, DICOM Store, NetCommit

Presentation Context Table					
Abstract Syntax		Transfer Syntax		Role	Ext. Negotiation
Name	UID	Name	UID		
CR Image Storage	1.2.840.10008.5.1.4.1.1.1	Little endian explicit and implicit VR	1.2.840.10008.1.2.1 1.2.840.10008.1.2	SCU	None
XA Image Storage	1.2.840.10008.5.1.4.1.1.12.1	Little endian explicit and implicit VR	1.2.840.10008.1.2.1 1.2.840.10008.1.2	SCU	None
RF Image Storage	1.2.840.10008.5.1.4.1.1.12.2	Little endian explicit and implicit VR	1.2.840.10008.1.2.1 1.2.840.10008.1.2	SCU	None
Secondary Capture Image Storage	1.2.840.10008.5.1.4.1.1.7	Little endian explicit and implicit VR	1.2.840.10008.1.2.1 1.2.840.10008.1.2	SCU	None
RT Image Storage	1.2.840.10008.5.1.4.1.1.481.1	Little endian explicit and implicit VR	1.2.840.10008.1.2.1 1.2.840.10008.1.2	SCU	None
DX Image Storage for Presentation	1.2.840.10008.5.1.4.1.1.1.1	Little endian explicit VR	1.2.840.10008.1.2.1	SCU	None
CT Image Storage	1.2.840.10008.5.1.4.1.1.2	Little endian explicit VR	1.2.840.10008.1.2.1	SCU	None
X-ray Radiation Dose Storage	1.2.840.10008.5.1.4.1.1.88.67	Little endian implicit VR	1.2.840.10008.1.2	SCU	None
Storage Commitment Push Model	1.2.840.10008.1.20.1	Little endian explicit and implicit VR	1.2.840.10008.1.2.1 1.2.840.10008.1.2	SCU	None

Ziehm Vision only supports Transfer Syntax Explicit VR. The Ziehm NetPort client does not attempt any extended negotiation.

A.3.2.1.3.1.3 SOP Specific Conformance DX and CT Image Storage on 3D devices

The user acquires a set of isocentric or non isocentric images, these images are saved in one series as DX images. On user demand a 3D image is generated and saved as 256 or 320 or 512 CT image series. Both series can be stored to the PACS.

On Ziehm Vision RFD 3D the isocentric images are saved as DICOM Multiframe with configured SOP Class.

A.3.2.1.3.1.4 Behavior of SCU in response to C_STORE_RSP Status

Table A.3.2-6

STORAGE C-STORE RESPONSE STATUS HANDLING BEHAVIOR

Error Code	Service Status	Behavior
0000	Success	Image successfully transmitted and flagged up with 'D'
B000	Warning: Element Coercion	Image successfully transmitted and flagged up with 'D'
B007	Warning: Data Set and SOP Class not consistent	Image successfully transmitted and flagged up with 'D'
B006	Warning: Elements discarded	Image successfully transmitted and flagged up with 'D'
all other Codes	Failure	Aborts association with error message: Failure!! Response from Server: <Status Code>

A.3.2.1.3.1.5 SOP Specific Conformance for Storage Commitment SOP Class

A.3.2.1.3.1.5.1 Storage Commitment Operations (N-ACTION)

The Ziehm NetPort AE will request storage commitment for instances of all Storage SOP Classes if the Remote AE is configured as an archive device and a presentation context for the Storage Commitment Push Model has been accepted. On Vision a special Commitment SCP is asked.

The Ziehm NetPort AE requests the safekeeping of a set of SOP Instances created with the Storage Service Class.

Table A.3.2-7

STORAGE COMMITMENT N-ACTION RESPONSE STATUS HANDLING BEHAVIOR

Error Code	Service Status	Behavior
0000	Success	Continues waiting for N_EVENT_REPORT, committed images are flagged up with 'C'.
all other Codes	Failure	Aborts association with error message: Failure!! Response from Server: <St. Code>

A.3.2.1.3.1.5.2 Behavior of SCU in response to N_EVENT_REPORT_RQ Status

The Remote AE informs the Ziehm NetPort AE through the N_EVENT_REPORT Response whether or not it has accepted Storage Commitment for the requested SOP Instances. The Ziehm NetPort AE only waits for N_EVENT_REPORT over the existing association (not Vision). Ziehm Vision waits asynchronously for N_EVENT_REPORT.

A private shutdown SOP Class "1.2.276.0.7230010.3.4.1915765545.18030.917282194.0" avoids acceptance of N_EVENT_REPORT_RQs during Fluoro-, Subtraction-, Vascular- and Radiography mode.

Table A.3.2-8

STORAGE COMMITMENT N-EVENT_REPORT RESPONSE STATUS HANDLING BEHAVIOR

Error Code	Service Status	Behavior
0000	Success	Examines Event Type ID: 1 = SUCCESS: image or image set is committed 3 = FAILURE, aborts association with Failure Reason tag (0008,1197) 2 = UNKNOWN in case 2,3 Ziehm NetPort shows a failure list
all other Codes	Failure	Aborts association with error message: Failure!! Response from server:<Failure Code>

A.3.2.2 Query/Retrieve Application Entity Specification

A.3.2.2.1 SOP Classes

The Ziehm NetPort AE provides Standard Conformance to the following SOP Classes:

Table A.3.2-9

SOP CLASSES FOR AE QUERY/RETRIEVE

SOP Class Name	SOP Class UID	SCU	SCP
Patient Root Q/R Information Model – FIND	1.2.840.10008.5.1.4.1.2.1.1	Yes	No
Patient Root Q/R Information Model – MOVE	1.2.840.10008.5.1.4.1.2.1.2	Yes	No
Study Root Q/R Information Model – FIND	1.2.840.10008.5.1.4.1.2.2.1	Yes	No
Study Root Q/R Information Model – MOVE	1.2.840.10008.5.1.4.1.2.2.2	Yes	No
Verification	1.2.840.10008.1.1	Yes	No

A.3.2.2.2 Association Policies (see A.3.2.1.2)

A.3.2.2.3 Association Initiation Policy

A.3.2.2.3.1 Activity – Query/Retrieve

A.3.2.2.3.1.1 Description and Sequencing of Activities

The request of Patient Data, Study Data, Series Data, Image Data and the displaying of a selected image is initiated by user interaction. The user select a patient ID and presses the Query button to get patient data, after saving the patient, the user can step through the DICOM information model to get data of each level (i.e. STUDY, SERIES, IMAGE). On level SERIES or IMAGE the user can move images to be displayed by pressing the button Retrieve.

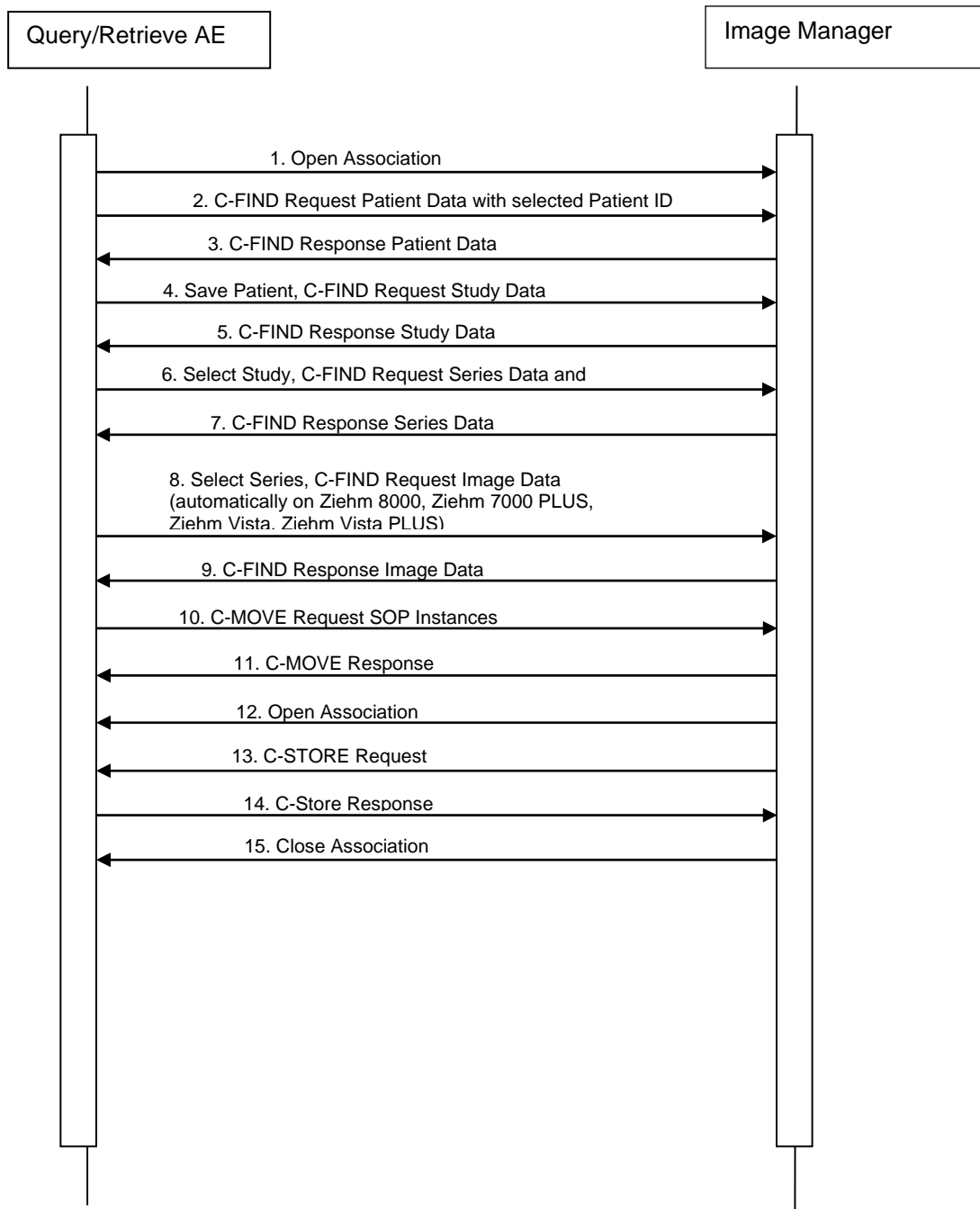

Step 7 and 9 for Therenva (Endonaut option) : DICOM object with special information will be forwarded to Endonaut software

Figure A.3.2-5
SEQUENCING OF ACTIVITY – Query/Retrieve

A.3.2.2.3.1.2 Proposed Presentation Contexts

Each time an association is initiated, the Ziehm NetPort SCU proposes one single Presentation Context to be used on that association.

Table A.3.2-10
**Proposed Presentation Contexts for Application Entity Ziehm NetPort
 and Real-World Activity Find and Move Request**

Presentation Context Table					
Abstract Syntax		Transfer Syntax		Role	Extended Negotiation
Name	UID	Name	UID		
Patient Root Q/R Information Model – FIND	1.2.840.10008.5.1.4.1.2.1.1	DICOM Implicit VR Little Endian	1.2.840.10008.1.2	SCU	None
Patient Root Q/R Information Model – MOVE	1.2.840.10008.5.1.4.1.2.1.2	DICOM Implicit VR Little Endian	1.2.840.10008.1.2	SCU	None
Study Root Q/R Information Model – FIND	1.2.840.10008.5.1.4.1.2.2.1	DICOM Implicit VR Little Endian	1.2.840.10008.1.2	SCU	None
Study Root Q/R Information Model – MOVE	1.2.840.10008.5.1.4.1.2.2.2	DICOM Implicit VR Little Endian	1.2.840.10008.1.2	SCU	None

A.3.2.2.3.1.3 SOP Specific Conformance for Query/Retrieve

The Tables A.3.2-11 – A.3.2-14 below contain the C-FIND message lists of attributes which is. Sent to the SCP. Each new level contains data from the level before. At last Table A.3.2-16 contains the attributes of the C-MOVE Request.

Table A.3.2-11
QUERY/RETRIEVE C-FIND REQUEST Attributes Level PATIENT Root

Name	Tag	VR	Value	Description
Query/Retrieve Level	0008,0052	CS	PATIENT	Constant
Accession Number	0008,0050	SH	*	Constant 1)
Patient's Name	0010,0010	PN	*	Constant 1)
Patient ID	0010,0020	LO	1	User supplied
Patient's Birth Date	0010,0030	DA	<null>	Constant
Patient's Sex	0010,0040	CS	<null>	Constant

1) Wildcard matching is displaced by single value matching with empty string (not Version 22.004)

Table A.3.2-12
QUERY/RETRIEVE C-FIND REQUEST Attributes Level STUDY

Name	Tag	VR	Value	Description
Query/Retrieve Level	0008,0052	CS	STUDY	Constant
Study Date	0008,0020	DA	<null>	Constant
Study Time	0008,0030	TM	<null>	Constant
Accession Number	0008,0050	SH	<null>	Constant
Referring Physicians Name	0008,0090	PN	<null>	Constant
Study Description	0008,1030	LO	<null>	Constant
Patient's Name	0010,0010	PN	test^person*	From PATIENT level, only STUDY ROOT
Patient ID	0010,0020	LO	1	From PATIENT level
Study Instance UID	0020,000D	UI	<null>	Constant
Study ID	0020,0010	SH	<null>	Constant

Table A.3.2-13
QUERY/RETRIEVE C-FIND REQUEST Attributes Level SERIES

Name	Tag	VR	Value	Description
Query/Retrieve Level	0008,0052	CS	SERIES	constant
Series Date	0008,0021	DA	<null>	constant
Series Time	0008,0031	TM	<null>	constant
Modality	0008,0060	CS	<null>	constant
Series Description	0008,103E	LO	<null>	constant
Patient ID	0010,0020	LO	1	Patient Root only
Study Instance UID	0020,000D	UI	2.16.840.1.113669.623.6.1.....	From Study Level
Series Instance UID	0020,000E	UI	<null>	constant
Series Number	0020,0011	IS	<null>	constant

Table A.3.2-14
QUERY/RETRIEVE C-FIND REQUEST Attributes Level IMAGE

Name	Tag	VR	Value	Description
Query/Retrieve Level	0008,0052	CS	IMAGE	Constant
SOP Instance UID	0008,0018	UI	<null>	Constant
Retrieve AE Title	0008,0054	AE	<null>	Constant
Patient ID	0010,0020	LO	1	Only PATIENT ROOT
Study Instance UID	0020,000D	UI	2.16.840.1.113669.632.6.1....	From level STUDY
Series Instance UID	0020,000E	UI	2.16.840.1.113669.632.6.1.....1	From level SERIES
Image Number	0020,0013	IS	<null>	Constant
Image Comments	0020,4000	LT	<null>	Constant
Storage Media File Set ID	0088,0130	SH	<null>	Constant
Storage Media File Set UID	0088,0140	UI	<null>	Constant

Table A.3.2-15
QUERY/RETRIEVE C-FIND RESPONSE STATUS HANDLING BEHAVIOR

Error Code	Service Status	Behavior
0000	Success	The SCP has completed the matches. C-Find messages are available for display. If no Pending-Status is sent, Ziehm NetPort displays an error message: No data on level ...
FF00,FF01	Pending	The SCP continues sending messages
All other codes	Failure	The Ziehm NetPort aborts association with error message: Failure!! Response from server:<Failure Code>

Table A.3.2-16
QUERY/RETRIEVE C-MOVE REQUEST Attributes Level IMAGE

Name	Tag	VR	Value	Description
Move Destination	0000,0600	AE	Ziehm NetPort AE	Ziehm NetPort AE
Query/Retrieve Level	0008,0052	CS	IMAGE	Constant
SOP Instance UID	0008,0018	UI	2.16.840.1.113669.6.1.....17	From level IMAGE
Patient ID	0010,0020	LO	1	Only PATIENT ROOT
Study Instance UID	0020,000D	UI	2.16.840.1.113669.632.6.1....	From level STUDY
Series Instance UID	0020,000E	UI	2.16.840.1.113669.632.6.1.....1	From level SERIES

Table A.3.2-17

QUERY/RETRIEVE C-MOVE RESPONSE STATUS HANDLING BEHAVIOR

Error Code	Service Status	Behavior
0000	Success	The Ziehm NetPort has successfully got the image from SCP. The Ziehm NetPort downsizes larger images to 576x576 matrix (or 1024x1024 matrix for Vision) or fills up to 576x576 (or 1024x1024) matrix, displays the image and saves into local data base. Retrieved images are flagged up with 'R' (only Vision).
FF00,FF01	Pending	The SCP continues sending messages
All other codes	Failure	The Ziehm NetPort aborts association with error message: Failure!! Response from server: <Failure Code> A801 = Destination unknown, Ziehm NetPort IP-address or hostname is not known by SCP C001 = Unable to process, Ziehm NetPort AE-Title or port-address is not known by SCP SW5.24/SW2.05: Failed: MoveDestinationUnknown = AE-Title Ziehm NetPort is not configured on server Failed: UnableToProcess = Port and/or IP-address Ziehm NetPort is not configured on server

A.3.2.2.4 Accepted SOP Storage Classes for Image Retrieve

The following Table A.3.2-18 shows the Storage SOP Classes accepted by Ziehm NetPort, the Table A.3.2-19 the accepted attributes of the retrieved image. Other images will not be displayed.

Image Retrieve accepts all incoming DICOM SOP Classes, the incoming objects will be analyzed. Objects with Image Data (DICOM Tag 7FE0,0010) will always be converted.

If the DICOM object contains the tag 0019,1405=Volume3D, it will be forwarded to the 3D application.

If the DICOM object contains the tag 0035,1000=THERENVA and SOP Class Encapsulated PDF Storage are called EndoSize Image and are forwarded to the EndoNaut server.

Other instances of SOP Class Class Encapsulated PDF are not supported for retrieve.

Table A.3.2-18

Valid SCU Store SOP Classes for Ziehm NetPort

Name of SOP Class	UID
MR Image Storage	1.2.840.10008.5.1.4.1.1.4
Computed Radiography Image Storage	1.2.840.10008.5.1.4.1.1.1
CT Image Storage	1.2.840.10008.5.1.4.1.1.2
Secondary Capture Image Storage	1.2.840.10008.5.1.4.1.1.7
Ultrasound Image Storage	1.2.840.10008.5.1.4.1.1.6.1
Ultrasound Multi-Frame Image Storage	1.2.840.10008.5.1.4.1.1.3.1
Nuclear Medicine Image Storage	1.2.840.10008.5.1.4.1.1.20
Standard X-ray Angiographic Image Storage	1.2.840.10008.5.1.4.1.1.12.1
Standard X-ray Angiographic Bi-Plane Image Storage	1.2.840.10008.5.1.4.1.1.12.3
Standard X-ray Radiofluoroscopic Image Storage	1.2.840.10008.5.1.4.1.1.12.2
Standard RT Image Storage	1.2.840.10008.5.1.4.1.1.481.1
Standard Positron Emission Tomography Image Storage	1.2.840.10008.5.1.4.1.1.128
Digital X-ray Image Storage- For Presentation	1.2.840.10008.5.1.4.1.1.1.1
Digital X-ray Image Storage- For Processing	1.2.840.10008.5.1.4.1.1.1.1.1
Digital Intra-oral X-ray Image Storage- For Presentation	1.2.840.10008.5.1.4.1.1.1.3
Digital Intra-oral X-ray Image Storage- For Processing	1.2.840.10008.5.1.4.1.1.1.3.1
Digital Mammography Image Storage- For Presentation	1.2.840.10008.5.1.4.1.1.1.2
Digital Mammography Image Storage- For Processing	1.2.840.10008.5.1.4.1.1.1.2.1
VL Endoscopic Image Storage	1.2.840.10008.5.1.4.1.1.77.1.1
VL Microscopic Image Storage	1.2.840.10008.5.1.4.1.1.77.1.2
VL Photographic Image Storage	1.2.840.10008.5.1.4.1.1.77.1.4
VL Slide-Coordinates Microscopic Image Storage	1.2.840.10008.5.1.4.1.1.77.1.3
Encapsulated PDF Storage	1.2.840.10008.5.1.4.1.1.104.1

Table A.3.2-19
Valid Image Attributes to display image

Tag	Name	VR	Description
0008,0018	SOP Instance UID	UI	displayed in case of error
0008,0023	Image Date	DA	Displayed
0008,0033	Image Time	TM	Displayed
0008,0080	Institution Name	LO	Displayed
0008,1050	Performing Physicians Name	PN	Displayed
0008,1090	Manufacturer's Model Name	LO	
0018,0060	KVP	DS	Displayed
0018,1151	X-ray Tube Current	IS	Displayed
0018,1000	Device Serial Number	LO	
0018,1020	Software Versions	LO	
0020,0013	Image Number	IS	C-arm creates own number
0020,4000	Image Comments	LT	max 64 character displayed
0028,0002	Samples per pixel	US	1,3
0028,0004	Photometric Interpretation	CS	MONOCROME1,MONOCHROME2,RGB
0028,0008	Number of Frames	IS	
0028,0010	Rows	US	max 5700
0028,0011	Columns	US	max 5700
0028,0100	Bits Allocated	US	8 or 16
0028,0101	Bits Stored	US	all smaller Bits Allocated
0028,0102	High Bit	US	Bits Stored – 1
0028,0103	Pixel Representation	US	0 (unsigned integer), 1(2's complement)
0028,0006	Planar Configuration	US	0, if Samples per pixel =3.. R1G1B1,
0028,0106	Smallest Image Pixel Value	US	
0028,0107	Largest Image Pixel Value	US	
0028,1050	Window Center	DS	only first value
0028,1051	Window Width	DS	only first value
0028,1052	Rescale Intercept	DS	
0028,1053	Rescale Slope	DS	
0028,1055	Window Center & Width Explanation	LO	
7FE0,0010	Pixel Data	OB/OW	only IMPLICIT LITTLE ENDIAN

A.3.2.3 Workflow Application Entity Specification

A.3.2.3.1 SOP Classes

The Ziehm NetPort AE provides Standard Conformance to the following SOP Classes:

Table A.3.2-19
SOP CLASSES FOR AE WORKLIST and MPPS

SOP Class Name	SOP Class UID	SCU	SCP
Modality Worklist Information Model – FIND	1.2.840.10008.5.1.4.31	Yes	No
Modality Performed Procedure Step	1.2.840.10008.3.1.2.3.3	Yes	No

A.3.2.3.2 Association Policies (see A.3.2.1.2)

A.3.2.3.3 Association Initiation Policy

A.3.2.3.3.1 Activity – Worklist

A.3.2.3.3.1.1 Description and Sequencing of Activities

The request for a Worklist is initiated by user interaction, i.e. pressing the button 'Worklist'.

On the device Ziehm 8000, Ziehm 7000 PLUS, Ziehm Vista, Ziehm Vista PLUS or Ziehm Vario3D: If the user wants to get the whole list of worklist items, he has to press the key 'Worklist'. The Ziehm NetPort AE requests all items for a Scheduled Procedure Step Date (actual date – not configurable), Modality (XA, CR,...), Scheduled Station AE Title (Ziehm NetPort AE or all) and Location (string or empty string), furthermore an interval of hours – Scheduled Procedure Start Time and Scheduled Procedure End Time – is possible. Modality, Scheduled Station AE Title, Location and timespan are configurable by a Service Engineer. The user can restrict the worklist items by a given patient ID and patient family name (wildcard matching).

On the Vision devices:

If the user wants to get the whole list of worklist items he has to press the worklist button and in the next dialog the button delete and the worklist button once more. The Ziehm NetPort AE request all items for a Scheduled Procedure Step Date, Modality (XA, CR, DX,.. or all), Scheduled Station AE Title (Ziehm NetPort AE or all) and Location (string or empty string). Modality, Scheduled Station AE Title, Location are configurable by a Service Engineer. The user can restrict the worklist items with a patient name – wildcard matching is possible –, a patient ID, the accession number and the requested procedure ID and Modality. Furthermore he can request a worklist from today, a fixed interval +/- 8 hours or -8 days or a scheduled date.

Upon initiation of the request, the Ziehm NetPort AE will build an Identifier for the C-FIND request, will initiate an Association to send the request and will wait for Worklist responses. After retrieval of all responses, Ziehm NetPort AE will display a list of all worklist items and the user can select one of them. With pressing 'Return' or 'Apply' the patient is saved in the local database, i.e. a new patient folder is created. Pressing 'Overwrite' the current patient will be overwritten by the worklist data.

The list can be sorted by patient name, first name, ID, date and time of scheduled procedure step. (Vision).

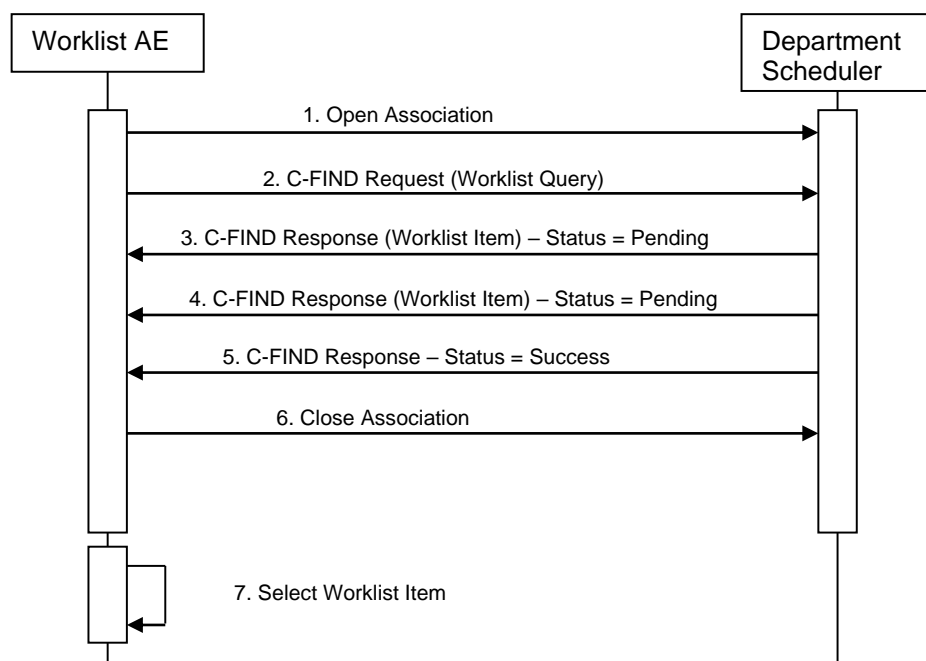

Figure A.3.2-5
SEQUENCING OF ACTIVITY – Worklist

A.3.2.3.3.1.2 Proposed Presentation Contexts

The Ziehm NetPort SCU proposes one single Presentation Context to be used on that association.

Table A.3.2-20
**Proposed Presentation Contexts for Application Entity Ziehm NetPort
 and Real-World Activity Find Request**

Presentation Context Table					
Abstract Syntax		Transfer Syntax		Role	Ext. Neg.
Name	UID	Name	UID		
Worklist Information Model – FIND	1.2.840.10008.5.1.4.31	DICOM Implicit VR Little Endian	1.2.840.10008.1.2	SCU	None

A.3.2.3.3.1.3 SOP Specific Conformance Statement

The behavior of Ziehm NetPort when encountering status codes in a Modality Worklist C-FIND response is summarized in the table below.

Table A.3.2-21
MODALITY WORKLIST C-FIND RESPONSE STATUS HANDLING BEHAVIOR

Error Code	Service Status	Behavior
0000	Success	provides valid Worklist Data, if exist else display message: No data
FF00,FF01	Pending	Ziehm NetPort is waiting for next item
A700	Refused-Out of Resources	provides valid Worklist Data, if exist and DICOM-Error A700 then aborts association
A900	Error: Data Set and SOP Class not consistent	DICOM-Error A900
C001	Error: unable to process , data from SCP not DICOM conform	as A700 with DICOM Error C001
FE00	user cancels	as A700

The table below provides a description of the Ziehm NetPort Worklist Request Identifier and specifies the attributes that are copied into the images. Unexpected attributed returned in a C-FIND response are ignored.

Table A.3.2-22
WORKLIST REQUEST IDENTIFIER

Module Name Attribute Name	Tag	VR	M	R	D	IOD	Note
SOP Common Specific Character Set	(0008,0005)	CS					ISO IR 100
Scheduled Procedure Step							
Scheduled Procedure Step Sequence	(0040,0100)	SQ		X			
➤ Scheduled Station AET	(0040,0001)	AE	S	X	X 2)		1)
➤ Scheduled Procedure Step Start Date	(0040,0002)	DA	RM	X	X	X	6)
➤ Scheduled Procedure Step Start Time	(0040,0003)	TM	RM	X	X	X	5)
➤ Modality	(0008,0060)	CS	S	X	X		4)
➤ Scheduled Performing Physician's Name	(0040,0006)	PN		X	X		
➤ Scheduled Procedure Step Description	(0040,0007)	LO		X	X		
➤ Scheduled Station Name	(0040,0010)	SH		X			
➤ Scheduled Procedure Step Location	(0040,0011)	SH	S	X			
➤ Scheduled Protocol Code Sequence (Scheduled Action Item Code Sequence)	(0040,0008)	SQ		X			2 Items (Vision)
>> Code Value	(0008,0100)	SH		X		X	
>> Code Scheme Designator	(0008,0102)	SH		X		X	
>> Code Meaning	(0008,0103)	LO		X	X	X	
➤ Scheduled Procedure Step ID	(0040,0009)	SH		X	X	X	
Requested Procedure							
➤ Requested Procedure ID	(0040,1001)	SH	S	X	X	X	
➤ Reason for Requested Procedure	(0040,1002)	LO				X	3)
➤ Requested Procedure Description	(0032,1060)	LO	3)	X	X	X	
➤ Requested Procedure Code Sequence	(0032,1064)	SQ					3)
>> Code Value	(0008,0100)	SH		X		X	
>> Code Scheme Designator	(0008,0102)	SH		X		X	
>> Code Meaning	(0008,0103)	SH		X	X	X	
➤ Study Instance UID	(0020,000D)	UI		X		X	
➤ Referenced Study Sequence	(0008,1110)	SQ					3)
>> Referenced SOP Class UID	(0008,1150)	UI		X		X	
>> Referenced SOP Instance UID	(0008,1155)	UI		X		X	
➤ Requested Procedure Priority	(0040,1003)	SH		X		X	
➤ Patient Transport Arrangements	(0040,1004)	LO		X		X	
Imaging Service Request							
➤ Accession Number	(0008,0050)	SH	S	X	X	X	
➤ Referring Physician's Name	(0008,0090)	PN	3)	X	X 3)	X	
➤ Requesting Physician	(0032,1002)	PN				X	3)
➤ Institution Address	(0008,0081)	ST				X	3)
Patient Identification							
➤ Patient's Name	(0010,0010)	PN	*	X	X	X	
➤ Patient ID	(0010,0020)	LO	S	X	X	X	
Patient Demographic							
➤ Patient's Birth Date	(0010,0030)	DA		X	X	X	
➤ Patient's Sex	(0010,0040)	CS		X	X	X	

The above table should be read as follows:

Module Name	The name of the associated module for supported worklist attributes
Attribute Name	Attributes supported by Ziehm NetPort Worklist Request Identifier
Tag	DICOM Tag for this attribute
VR	DICOM Value Representation for this Attribute
M	Matching Keys, i.e. S= Single Value Matching, RM= Range Matching, *= Wildcard Matching
R	Return Keys with zero length for Universal Matching
D	Displayed Keys
WL	Worklist
IOD	Tag will be saved in local data base for MPPS and DICOM Storage
1)	Single Value Matching Ziehm NetPort AE or Universal Matching
2)	Not Vision
3)	Only Vision
4)	Single Value Matching for XA, CR or Universal Matching (additional on Ziehm Vision: DX, ES, RF, RG, PX, CT, OT, RT, SC, CT_E)
5)	If TIME range expires midnight, a second request to SCP is started
6)	Today, any desired date, time span of 8 days into the past

A.3.2.3.3.2 Activity – MPPS

A.3.2.3.3.2.1 Description and Sequencing of Activities

After selecting a worklist item, the patient is saved in the local database and a new patient folder is created. If MPPS is activated the Ziehm NetPort establishes automatically an Association to the configured MPPS SCP, sends an N_CREATE to set the Procedure Step into the State "IN PROGRESS".

Ziehm NetPort supports the creation of "unscheduled cases" on all devices.

Ziehm NetPort supports 0-1, 1-1 relationship between Scheduled and Performed Procedure Steps, on device Ziehm Vision the 1-N relationship is supported (Append case).

With a successful Storage of one or more images to the PACS Ziehm NetPort establishes a second Association to the MPPS SCP, sends an N_SET to set the Procedure Step into the state "COMPLETED". On Ziehm Vision it is also possible to set state "DISCONTINUED".

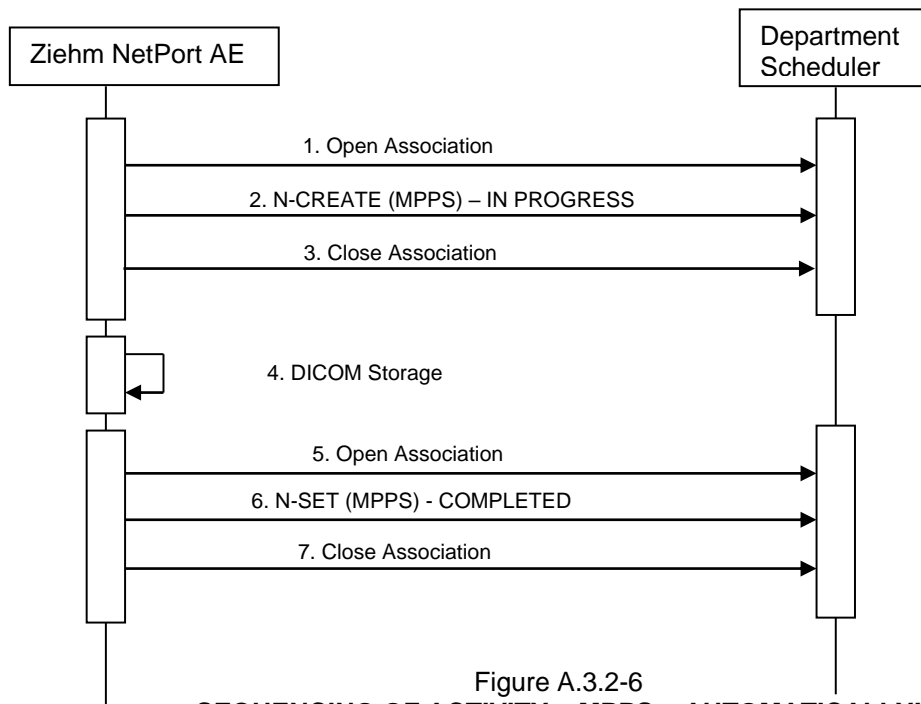

Figure A.3.2-6
SEQUENCING OF ACTIVITY – MPPS – AUTOMATICALLY!

A.3.2.3.3.2 Proposed Presentation Contexts

Table A.3.2-23
**Proposed Presentation Contexts for Application Entity Ziehm NetPort
 and Real-World Activity MPSS**

Presentation Context Table					
Abstract Syntax		Transfer Syntax		Role	Extended Negotiation
Name	UID	Name	UID		
Modality Performed Procedure Step	1.2.840.10008.3.1.2.3.3	DICOM Implicit VR Little Endian	1.2.840.10008.1.2	SCU	None

A.3.2.3.3.3 SOP Specific Conformance for MPSS

The behavior of Ziehm NetPort when encountering status code in an MPSS N-CREATE or N-SET response is summarized in Table A.3.2-24.

Table A.3.2-24
MPSS N-CREATE/ N-SET RESPONSE STATUS HANDLING BEHAVIOR

Error Code	Service Status	Behavior
0000	Success	Returns tag 0000,1000 in data-File
all other Codes	Failure	Aborts association with error message: Failure!! Response from server:<Error Code>

Table A.3.2-25 provides a description of the MPSS M-CREATE and N-SET request identifiers sent by Ziehm NetPort.

Table A.3.2-25
MPSS N-CREATE/ N-SET REQUEST IDENTIFIER

Attribute Name	Tag	VR	N-CREATE	N-SET
Specific Character Set	(0008,0005)	CS	ISO IR 100	
Modality	(0008,0060)	CS	XA, CR	
Procedure Code Sequence	(0008,1032)	SQ	From WL	
>>Code Value	(0008,0100)	SH		
>>Coding Scheme Designator	(0008,0102)	SH		
>>Code Meaning	(0008,0104)	LO		
Referenced Patient Sequence	(0008,1120)	SQ	Zero Length	
Patient's Name	(0010,0010)	PN	From WL or input: Family^Given	
Patient ID	(0010,0020)	LO	from WL or user input	
Patient's Birth Date	(0010,0030)	DA	from WL or user input	
Patient's Sex	(0010,0040)	CS	from WL or user input	
Image Area Dose Product	(0018,115E)	DS	Zero Length	1) in dGy*cm*cm
Distance Source to Detector(SID)	(0018,1110)	DS	Zero Length	970/970/1110 mm 3)
Study ID	(0020,0010)	SH	=Tag (0040,1001)	
Performed Station AE Title	(0040,0241)	AE	Ziehm NetPort AE Title	
Performed Station Name	(0040,0242)	SH	Ziehm NetPort AE Title	
Performed Location	(0040,0243)	SH	from configuration	
Performed Proc. Step Start Date	(0040,0244)	DA	CreateDate of patient folder	
Performed Proc. Step Start Time	(0040,0245)	TM	CreateTime of patient folder	
Performed Proc. Step End Date	(0040,0250)	DA	Zero Length	Actual end date
Performed Proc. Step End Time	(0040,0251)	TM	Zero Length	Actual end time

Attribute Name	Tag	VR	N-CREATE	N-SET
Performed Procedure Step Status	(0040,0252)	CS	IN PROGRESS	COMPLETED DISCONTINUED (Vision)
Performed Procedure Step ID	(0040,0253)	SH	Input or created by device	
Performed Procedure Step Desc.	(0040,0254)	LO	Zero Length	
Performed Proc. Type Desc.	(0040,0255)	LO	Zero Length	
Performed Protocol Code Seq.	(0040,0260)	SQ	from (0040,0008)	
>>Code Value	(0008,0100)	SH		
>>Coding Scheme Designator	(0008,0102)	SH		
>>Code Meaning	(0008,0104)	LO	2)	
Scheduled Step Attribute Seq.	(0040,0270)	SQ		
> Referenced Study Sequence	(0008,1110)	SQ	From WL	
>>Referenced SOP Class UID	(0008,1150)	UI		
>>Referenced SOP Instance UID	(0008,1155)	UI		
> Study Instance UID	(0020,000D)	UI	From WL or created by Ziehm NetPort	
> Accession Number	(0008,0050)	SH	From WL or input	
> Requested Procedure Desc.	(0032,1060)	LO	From WL	
> Scheduled Proc. Step Desc.	(0040,0007)	LO	From WL	
> Scheduled Protocol Code Seq.	(0040,0008)	SQ	From WL	
>> Code Value	(0008,0100)	SH		
>> Coding Scheme designator	(0008,0102)	SH		
>> Code Meaning	(0008,0104)	LO		
> Scheduled Procedure Step ID	(0040,0009)	SH	From WL	
> Requested Procedure ID	(0040,1001)	SH	From WL	
Performed Series Sequence	(0040,0340)	SQ	Zero Length	
> Retrieve AE Title	(0008,0054)	AE		AE Title of Image Manager
> Series Description	(0008,103E)	LO		(0032,1060) from Worklist
> Performing Physician's Name	(0008,1050)	PN		User input
> Operator's Name	(0008,1070)	PN		Configuration
> Referenced Image Sequence	(0008,1140)	SQ		One or max 20 items
>>Referenced SOP Class UID	(0008,1150)	UI		SOP Class from Storage Configuration
>>Referenced SOP Instance UID	(0008,1155)	UI		SOP Instance of image
> Protocol Name	(0018,1030)	LO		Code Meaning from (0040,0260)
> Series Instance UID	(0020,000E)	UI		Created by Ziehm NetPort
> Series Description	(0008,103E)	LO		User input
> Referenced Standalone SOP Instance Sequence	(0040,0220)	SQ	Zero Length (not supported)	Zero Length (not supported)
Total Time of Fluoroscopy	(0040,0300)	US	Zero length	Total Time in sec
Total Number of Exposures	(0040,0301)	US	Zero length	Number Exposures
Distance Source to Entrance	(0040,0306)	DS	Zero length	SID –200 mm
Exposure Dose Sequence	(0040,030E)	SQ		Same number of items as (0008,1140)
> KVP	(0018,0060)	DS	-	A 8.1-18
> Exposure Time	(0018,1150)	IS	-	A 8.1-18
> Radiation Mode	(0018,115A)	CS	-	CONTINUOUS/PULSED /PULSED (3
> Filter Type	(0018,1160)	SH	-	FLAT
> Filter Material	(0018,7050)	CS	-	ALUMINIUM/COPPER
> X-ray Tube Current in μ A	(0018,8151)	DS	-	A 8.1-18

*1) WARNING for Ziehm 8000, Ziehm 7000 PLUS, Ziehm Vista, Ziehm Vista PLUS, Ziehm Vario 3D:
to get consistent value, save image after last X-ray

*2) Ziehm Vision supports IHE requirements (Manual Modality Setting)

*3) Ziehm Vision / Ziehm Vision FD / Ziehm Vista

A.3.2.3.4 Association Acceptance Policy

Since the Ziehm NetPort AE is a Service Class User only, it will never accept associations.

A.3.2.4 Print Management Application Entity Specification

A.3.2.4.1 SOP Classes

Ziehm NetPort provides Standard Conformance to the following SOP Classes:

Table A.3.2-26
SOP CLASSES FOR AE PRINT MANAGEMENT

SOP Class Name	SOP Class UID	SCU	SCP
Basic Grayscale Print Management Meta	1.2.840.10008.5.1.1.9	Yes	No
Presentation LUT (only Vision)	1.2.840.10008.5.1.1.23	Yes	No

A.3.2.4.2 Association Policies (see A.3.2.1.2)

A.3.2.4.3 Association Initiation Policy

A.3.2.4.3.1 Activity – DICOM Print

A.3.2.4.3.1.1 Description and Sequencing of Activities

A user composes images onto film sheets by marking them on the appliance. On Ziehm 8000, Ziehm 7000 PLUS, Ziehm Vista, Ziehm Vista PLUS or Ziehm Vario 3D the user can select the number of copies, the Film Destination, the Size ID, Number of Images per Page and can insert a Film Session Label. Otherwise these data are configurable by a service engineer.

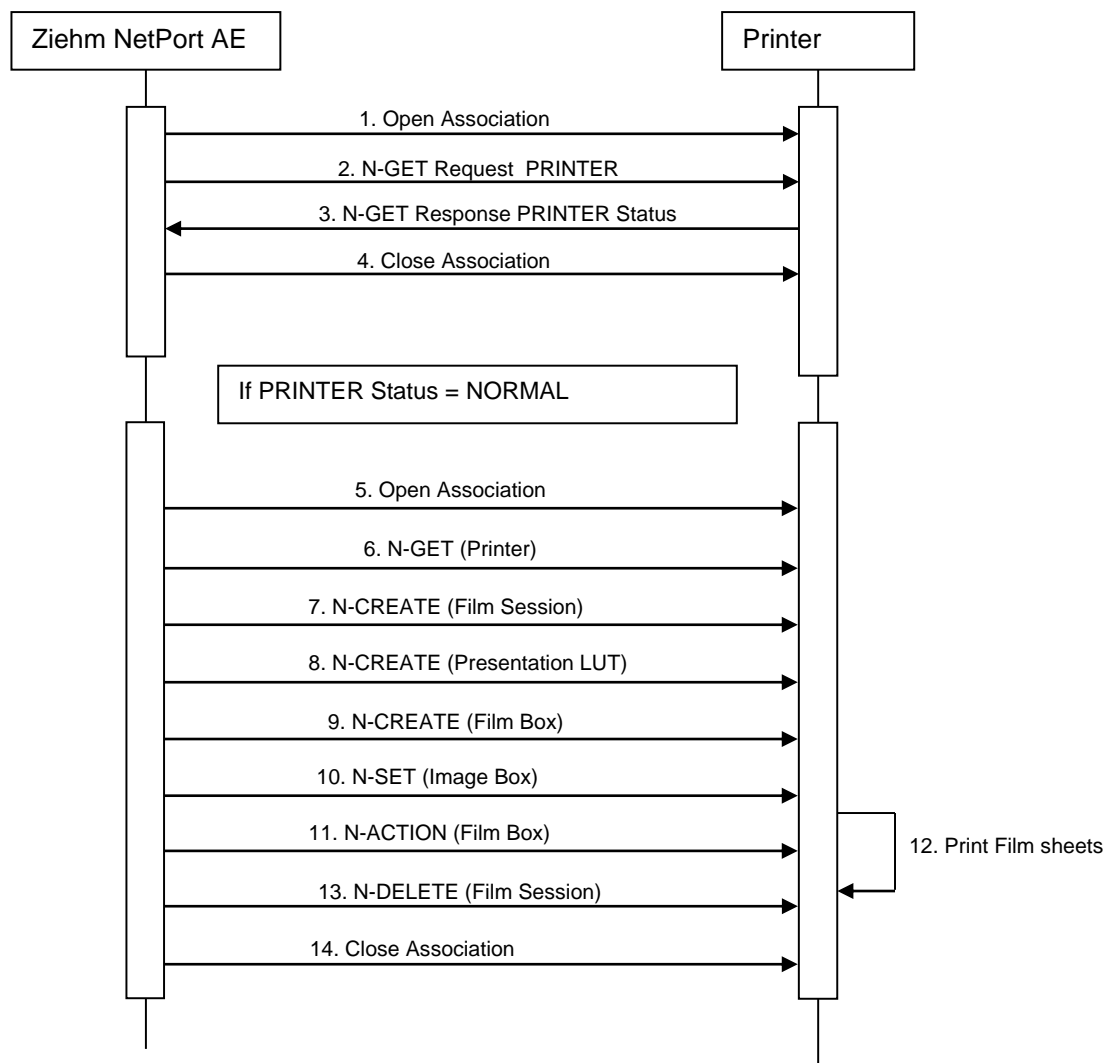

Figure A.3.2-7
SEQUENCING OF ACTIVITY – DICOM PRINT

The Ziehm NetPort AE opens one association at a time, first it sends a Printer N_GET Request to get the Printer Status. If the Status is "NORMAL", it sends a Basic Film Session N_CREATE message to the SCP, followed by a Basic Film Box, N_CREATE message. Then it sends a Basic Grayscale Image Box, N_SET message. At the end an N_ACTION message is sent to instruct the Print SCP to print at the Basic Film Session (1 page) or at the Basic Film Box level (more than 1 page). If Printer supports Presentation LUT, Ziehm NetPort sends Presentation LUT N_CREATE.

A.3.2.4.3.1.2 Proposed Presentation Contexts

The Ziehm NetPort provides Standard Conformance to the DICOM Basic Grayscale Print Management Meta SOP class as a SCU. The proposed context is only the bold printed line in the table.

Table A.3.2- 27
PROPOSED PRESENTATION CONTEXTS FOR ACTIVITY DICOM PRINT

Presentation Context Table					
Abstract Syntax		Transfer Syntax		Role	Ext. Neg.
NAME	UID	NAME	UID		
Basic Grayscale Print Management Meta	1.2.840.10008.5.1.1.9	DICOM Implicit VR Little Endian	1.2.840.10008.1.2	SCU	None
Basic Film Session	1.2.840.10008.5.1.1.1	DICOM Implicit VR Little Endian	1.2.840.10008.1.2	SCU	None
Basic Film Box	1.2.840.10008.5.1.1.2	DICOM Implicit VR Little Endian	1.2.840.10008.1.2	SCU	None
Basic Grayscale Image Box	1.2.840.10008.5.1.1.4	DICOM Implicit VR Little Endian	1.2.840.10008.1.2	SCU	None
Printer	1.2.840.10008.5.1.1.16	DICOM Implicit VR Little Endian	1.2.840.10008.1.2	SCU	None
Presentation LUT (only Vision)	1.2.840.10008.5.1.1.23	DICOM Implicit VR Little Endian	1.2.840.10008.1.2	SCU	None

A.3.2.4.3.1.3 SOP Specific Conformance all Print Management SOP Classes

A.3.2.4.3.1.3.1 Printer SOP Class Operation (N-Get)

Ziehm NetPort uses Printer SOP Class N-GET operation to obtain information about the current printer status. The attributes obtained via N-GET are listed in the table below:

Table A.3.2-28
PRINTER SOP CLASS N-GET REQUEST ATTRIBUTES

Attribute Name	Tag	VR	Value	Presence of Value	Source
Printer Status	(2110,0010)	CS	Provided by Printer	ALWAYS	Printer
Printer Status Info	(2110,0020)	CS	Provided by Printer	ALWAYS	Printer

The Printer Status information is evaluated as follows:

1. If Printer Status (2120,0010) is NORMAL, the print job continues to be printed.
2. If not, the Printer Status Info is reported to the user and the print job is stopped, see table below:

Table A.3.2-29
PRINTER SOP CLASS N-GET RESPONSE STATUS HANDLING BEHAVIOR

Error Code	Service Status	Behavior
0000	Success	continues creating Film Session
All other Codes and Printer Status is not "NORMAL"	Failure	aborts association with error message: Failure!! Response from Printer: <Status Code> Vision aborts only in case of "FAILURE"

A.3.2.4.3.1.3.2 Film Session SOP Class Operations

The Ziehm NetPort supports the following DIMSE operations for the Film Session SOP Class:

- N-CREATE
- N-ACTION
- N-DELETE

The attributes supplied in an N_CREATE Request are listed in the table below:

Table A.3.2-30

FILM SESSION SOP CLASS N-CREATE REQUEST ATTRIBUTES

Attribute Name	Tag	VR	Value
Number of Copies	(2000,0010)	IS	1..10
Print Priority	(2000,0020)	CS	user defined : HIGH, MED, LOW or default of SCP
Medium Type	(2000,0030)	CS	user defined: PAPER, BLUE FILM, CLEAR FILM or default of SCP
Film Destination	(2000,0040)	CS	user defined: PROCESSOR, MAGAZINE, BIN_i (i=1..10) or default of SCP
Film Session Label	(2000,0050)	LO	user defined

Table A.3.2-31

FILM SESSION SOP CLASS N-CREATE, N-ACTION, N-DELETE RESPONSE STATUS HANDLING BEHAVIOR

Error Code	Service Status	Behavior
0000	Success	continues creating Film Session
All other Codes	Failure	aborts association with error message: Failure!! Response from Film Session ..: <Error Code>

A.3.2.4.3.1.3.3 Basic Film Box SOP Class Operations

The Ziehm NetPort supports the following DIMSE operations for the Basic Film Box SOP Class:

- N-CREATE
- N-ACTION

The attributes supplied in an N_CREATE Request are listed in the table below:

Table A.3.2-32

FILM BOX SOP CLASS N-CREATE REQUEST ATTRIBUTES

Attribute Name	Tag	VR	Value
Image Display Format	(2010,0010)	CS	STANDARD\C,R C=1..4 R=1..6
Referenced Film Session Sequence	(2010,0500)	SQ	
Ref SOP Class UID	(0008,1150)	UI	1.2.840.10008.5.1.1.1
Ref SOP Instance UID	(0008,1155)	UI	returns from SCP when FILM Session is created
Film Orientation	(2010,0040)	CS	PORTRAIT/LANDSCAPE
Film Size ID	(2010,0050)	CS	user defined: 8INX10IN, 8_5INX11IN, 10INX12IN, 10INX14IN, 11INX14IN, 11INX17IN, 14INX14IN, 14INX17IN,24CMX24CM, 24CMX30CM, A4, A3 or default of SCP
Magnification Type (only Vision)	(2010,0060)	CS	REPLICATE/BILINEAR/CUBIC/NONE
Min Density	(2010,0120)	US	0..65535
Max Density	(2010,0130)	US	0..65535
Referenced Presentation LUT Sequence	(2050,0500)	SQ	If Presentation LUT is created
> SOP Class UID	(0008,1150)	UI	1.2.840.10008.5.1.1.23

Attribute Name	Tag	VR	Value
> SOP Instance UID	(0008,1155)	UI	From SCP when Presentation LUT is created
Illumination	(2010,015E)	US	150 cd/m ² for Medium Type=PAPER 2000 cd/m ² others
Reflected Ambient Light	(2010,0160)	US	10 cd/m ² for Media Type Film

Table A.3.2-33

FILM BOX SOP CLASS N-CREATE, N-ACTION RESPONSE STATUS HANDLING BEHAVIOR

Error Code	Service Status	Behavior
0000	Success	Continues creating Film Session
All other Codes	Failure	Aborts association with error message: Failure!! Response from Film Box ..: <Error Code>

A.3.2.4.3.1.3.4 Basic Grayscale Image Box SOP Class Operation (N-SET)

The attributes supplied in an N-SET Request are listed in the table below:

Table A.3.2-34

BASIC GRAYSCALE IMAGE BOX SOP CLASS N-SET REQUEST ATTRIBUTES

Attribute Name	Tag	VR	Value
Image Position	(2020,0010)	US	1..max24
Basic Grayscale Image Sequence	(2020,0110)	SQ	
> Samples Per Pixel	(0028,0002)	US	1
> Photometric Interpretation	(0028,0004)	US	MONOCHROME2
> Rows	(0028,0010)	US	576 or 1024
> Columns	(0028,0011)	US	576 or 1024
> Bits Allocated	(0028,0100)	US	8
> Bits Stored	(0028,0101)	US	8
> High Bit	(0028,0102)	US	7
> Pixel Representation	(0028,0103)	US	0
> Pixel Data	(7FE0,0010)	OW	

Table A.3.2-35

BASIC GRAYSCALE IMAGE BOX SOP CLASS N-SET RESPONSE STATUS HANDLING BEHAVIOR

Error Code	Service Status	Behavior
0000	Success	continues creating Film Session
All other Codes	Failure	Aborts association with error message: Failure!! Response from Image Box ..: <Error Code>

A.3.2.4.3.1.3.5 Presentation LUT SOP Class Operations

The Ziehm NetPort supports the following DIMSE operations for the Presentation LUT Session SOP Class:

- N-CREATE

If the server supports Presentation LUT SOP Class, the Affected SOP Instance UID is expected in the response message.

The attributes supplied in an N_CREATE Request are listed in the table below:

Table A.3.2-36

PRESENTATION LUT SOP CLASS N-CREATE REQUEST ATTRIBUTES

Attribute Name	Tag	VR	Value
Presentation LUT Shape	(2050,0020)	CS	IDENTITY

Table A.3.2-37
PRESENTATION LUT N-CREATE RESPONSE STATUS HANDLING BEHAVIOR

Error Code	Service Status	Behavior
0000	Success	continues
All other Codes	Failure	aborts association <Error Code>

A.3.2.4.4 Association Acceptance Policy

The Ziehm NetPort AE does not accept Associations.

A.3.3 NETWORK INTERFACES

A.3.3.1 Physical Network Interface

Ziehm NetPort supports a single network interface. One of the following physical network interfaces will be available depending on installed hardware options:

Table A.3.3-1
SUPPORTED PHYSICAL NETWORK INTERFACES

Ethernet 10/100base T, Gigabit Ethernet
Wireless LAN WPA2 with AES and Preshared Key WPA2 Enterprise

A.3.3.2 Additional Protocols

Ziehm NetPort does not support LDAP.

Table A.3.3-2
NETWORK PARAMETERS

Parameter	Value
Ziehm NetPort (or Vario) IP Address	configurable <i>Please avoid leading zeros on the Vision unit!</i>
Ziehm NetPort Hostname	Vision: configurable Other devices: set to AE-Title Ziehm NetPort!
DNS	Vision: 2 name servers configurable Others: no <i>Please avoid leading zeros on the Vision unit!</i>
DHCP	Vision: yes Others: no
Gateway	configurable <i>Please avoid leading zeros on the Vision unit!</i>
Subnet mask	configurable <i>Please avoid leading zeros on the Vision unit!</i>
IP Address SCP	configurable <i>Please avoid leading zeros on the Vision unit!</i>
Hostname SCP	Vision: configurable Others: no
Domain name	Vision: configurable Others: no
Broadcast address	Not configurable
Open Web Socket Protocol RFC 6455 (Client)	With SW 7.06.7 / 7.07.3 Web Socket Connection to Remote Service Port configurable Configuration of Proxy-Server possible
SNTP (Client)	Vision: configurable in dis8000.ini With SW 6.05: 2 timeservers (configurable) With SW 7.07: timezone selectable from drop-down/list box

A.3.4 CONFIGURATION

A.3.4.1 AE Title/Presentation Address Mapping

A.3.4.1.1 Local AE Title(s) and Port(s)

The service engineer can configure the Ziehm NetPort AE Title(s) and the TCP/IP Port(s) in the service dialog. The dialog is protected with a password.

Table A.3.4-1
LOCAL AE-Title and Port Ziehm NetPort

Device	AE-Title	Port
Ziehm Vision	Configurable, same for every Application (including Vision Vario)	Configurable, please use value > 1024 With SW 6.00ff: free configurable With SW 7.07ff: refer to blacklist in Technical Manual for blocked ports
Ziehm Vario 3D Workstation	Configurable	Configurable
All other	Configurable, for each Application Please use always the same, because it is set to Hostname!	104, not configurable 1025 V2-0,5K

A.3.4.1.2 Remote AE Titles and Ports

The service engineer can configure the SCP AE Title(s) and the TCP/IP Port(s) in the service dialog. The dialog is protected with a password. On the device Ziehm Vision the service engineer has the possibility to "CLONE" a server: Press button "Clone", "Save", leave the dialog "DICOM", return to the dialog "DICOM", you will find a new server in this section. You cannot delete cloned servers. On all other devices the number of servers is hard coded.

With the button "Verify" or "Test" (Ziehm Vision) first the network connection is tested with "ping". If the ping-command fails, the error message "server not reachable" or "ping failed" is displayed for 2 seconds, then Ziehm NetPort starts the Association Negotiation. Table A.3.4-2 lists the list of possible error-messages:

Table A.3.4-2
ERROR MESSAGES DICOM VERIFICATION

Error Message	Reason(s)
No connection to server Ping failed (Ziehm Vision) SW5.03: Echo failed for security reason SW1.03: ... (Ping failed)	1. Server is not switched on 2. Or network parameter not correct Table 3.3-2 Please check!
Failed to connect to remote host <i>Until SW15: No connection to server</i> With SW5.24: Failed to establish association	1. IP address of SCP or Port of SCP is wrong 2. Or Subnet Mask is wrong Please check!
Unable to resolve host name to IP address <i>Until SW15: No connection to server</i> With SW5.22: - no longer -	1. Please write hostname of SCP to IP address of SCP
Association negotiation failed <i>Until SW15: System Error 23</i> With SW5.24: Association rejected: Wrong server (client) aetitle	1. AE Title or Port of SCP not correct 2. AE Title Ziehm NetPort is not correct Please check!
Connection aborted before association negotiation was completed <i>Until SW15: No response from server</i> With SW5.24: Failed to establish association	1. Application SCP is not started 2. Port SCP not correct Please check!

Error Message	Reason(s)
Required Configuration Info Missing Message service unacceptable for this association <i>Until SW15: No response from server</i> With SW5.24: - no longer -	1. wrong mergecom.app -> please order Software Update
Network unexpectedly shut down	1. Association Negotiation is ok! SCP sends no ECHO-Response
MERGE.INI cannot be loaded <i>Until SW15: System Error 23</i> With SW5.24: - no longer -	1. DOS-Version: Wrong autoexec.bat 2. LINUX-Version: Software Bug Please order Software Update
PC/TCP resident module is not loaded; aborting program <i>Until SW15: No connection to server</i> - no longer in Linux versions -	Only in DOS-Versions: 1. Driver of network card is not loaded or wrong autoexec.bat or pctcp.ini Please call service hotline

Errors are logged to the file DicomLog.html/dicom.log/merge.log, retrieval from the device to floppy/usb disc is possible in the Service dialog.

A.3.4.1.2.1 Storage and Storage Commitment SCP AE Titles and Ports

Table A.3.4-2
REMOTE AE-Title and Port STORAGE/Commitment SCP

Device	AE-Title	Port	Max. #	Names of servers 1)	Functionality
Vision	Configurable	Configurable	5	Until SW 5.30.3: Configurable in section Storage <name1>=1 <name2>=2 <name3>=3 <name0>=0 <name4>=4 <name5>=5 versions 4.xx: net_storage_server = 1 SW 6.00ff: Activate server via checkbox	Active Storage Active 2D- Navigation Commitment Inactive Storage Inactive Navigation DICOM Dose Server SW 6.00ff: offers configuration sections for 2D/3D Navigation and Commitment and RDSR export
All other	Configurable	Configurable	2	Storage Server Print Server with Function Storage2	

A.3.4.1.2.2 Query/Retrieve SCP AE Titles and Ports

The service engineer can select between STUDY_ROOT and PATIENT_ROOT.

Table A.3.4-5
REMOTE AE-Title and Port QUERY/RETRIEVE SCP

Device	AE-Title	Port	Max #	Names of servers 2)	Functionality
Ziehm Vision	Configurable	Configurable	5	Until SW 5.30.3: Configurable in section Query <name1>= 1 <name0>= 0 Versions 4.xx: net_query_server=1 SW 6.00ff: Activate Query server via checkbox	Query/Retrieve Retrieve
Ziehm Vario 3D Workstation	-	-	-	-	-
All other	Configurable	Configurable	1 2	Query Server Retrieve Server 1	

A.3.4.1.2.3 Worklist and MPPS SCP AE Titles and Ports

Table A.3.4-6
REMOTE AE-Title and Port WORKLIST AND MPPS SCP

Device	AE-Title	Port	Max #	Names of servers 3)	Functionality
Ziehm Vision	Configurable	Configurable	5	Until SW 5.30.3: Configurable in section Worklist <name1>=1 <name2>=2 <name0>=0 Version 4.xx net_worklist_server=1 net_mpps_server=1 SW 6.00ff: Activate Worklist or MPPS server via checkbox	Worklist MPPS Inactive server SW 6.00ff: offers configuration sections for MPPS and WL
Ziehm Vario3D Workstation	Not supported	Not supported	-	-	
All other	Configurable	Configurable	1 1	Worklist Server MPPS Server	

Table A.3.4-7
MATCHING KEYS FOR WORKLIST

Device	Attributes Name	Tag	Value
all	Modality	(0008,0060)	XA or CR or all or DX, ES, RF, RG, PX, CT, OT(Vision)
all	Station AE Title	(0040,0001)	Yes = Ziehm NetPort AE Title No = all Empty (Vision only) Any AE Title (Vision only)
all	Location	(0040,0011)	<string> or empty
Not Vision	Time Date	(0040,0003) (0040,0002)	Range of hours Input: -24 – 24 = yesterday and today 00 – 24 = today 24 – 00 = yesterday +09 – 15 = today from 9 until 15 o'clock 10 – 10 = yesterday from 14 o'clock until today 10 o'clock

A.3.4.1.2.4 Print SCP AE Titles and Ports

Table A.3.4-8
REMOTE AE-Title and Port PRINT SCP

Device	AE-Title	Port	Max #	Names of servers 4)	Functionality
Ziehm Vision	Configurable	Configurable	5	Until SW 5.30.3: Configurable in section print <name1>=1 <name0>=0 Version 4.xx: Net_print-server=1 SW 6.00ff: Activate server via checkbox	Print Inactive server
Ziehm Vario3D Workstation	Not supported	Not supported	–	–	
All other	Configurable	Configurable	2	Print Server 1 with Function Print Print Server 2	

Table A.3.4-9
CONFIGURABLE ATTRIBUTES FOR PRINT SCP

Attribute Name	Tag	VR	Value
Number of Copies	(2000,0010)	IS	1..10
Print Priority	(2000,0020)	CS	user defined : HIGH, MED, LOW or default of SCP
Medium Type	(2000,0030)	CS	user defined: PAPER, BLUE FILM, CLEAR FILM or default of SCP
Film Destination	(2000,0040)	CS	user defined: PROCESSOR, MAGAZINE, BIN_i (i=1..10) or default of SCP
Film Session Label	(2000,0050)	LO	user defined
Film Size ID	(2010,0050)	CS	user defined: 8INX10IN, 8_5INX11IN, 10INX12IN, 10INX14IN, 11INX14IN, 11INX17IN, 14INX14IN, 14INX17IN, 24CMX24CM, 24CMX30CM, A4, A3 or default of SCP
Min Density	(2010,0120)	US	0..65535
Max Density	(2010,0130)	US	0..65535
Image Display Format (Number per Page)	(2010,0010)	CS	STANDARD\C,R C=1..4 R=1..6 1 -> STANDARD\1,1 ... 24 -> STANDARD\4,6

Ziehm 8000, Ziehm 7000 PLUS, Ziehm Vista, Ziehm Vista PLUS allows to change Tag (2000,0030), (2000,0040), (2000,0050) and (2010,0010), (2010,0050) also on user level.

Note 1)- 4) Name of Servers: DO NOT use reserved names: "Client", "Servers", "Storage", "Query", "Worklist", "Print", "echo", "dicom_media"

Please DO NOT use names twice!

A.3.4.2 Configuration Files

The Ziehm NetPort application uses the MergeCOM-3 subroutine library from Merge Healthcare (see A 3.5) Linux Version 3.30 IB 25, Ziehm Vario 3D Workstation uses the DCMTK subroutine library Version 3.5.4.

The Ziehm NetPort application references the following configuration files:

dicomConfig.ini	Replaces ae_titel.new in SW 6.00 and above
etc/hosts	Specifies IP addresses of the Ziehm device, localhost query/retrieve and storage commitment servers (DOS versions only)
etc/hostname	Contains the hostname of the device
etc/network/interfaces	In Linux operating systems (OS) for network configuration
etc/dhcp/dhclient.conf	In Linux OS for DHCP configuration
ae_titel.dat (new)	Specifies the AE title and the network parameter for the Ziehm NetPort application and the remote SCP applications. This file is configured using a GUI dialog on the C-arm console.

Versions with MergeCOM-3 subroutine library reference four more configuration files:

The file merge.ini, is found through the MERGE_INI environment variable. They are as follows:

merge.ini	Specifies the names of three configuration files and also contains message logging parameters
mergecom.pro	Specifies run-time parameters for the Ziehm NetPort application
mergecom.srv	Service and sequence definitions
mergecom.app	Specifies DICOM services that will be negotiated with the SCPs

With SW 5.24 and SW 2.05 the MergeCOM-3 library is replaced by OFFIS DICOM Toolkit (Vision only), only configuration file ae_titel.dat (new) is used.

A.4 MEDIA INTERCHANGE

A.4.1 IMPLEMENTATION MODEL

A.4.1.1 Application Data Flow

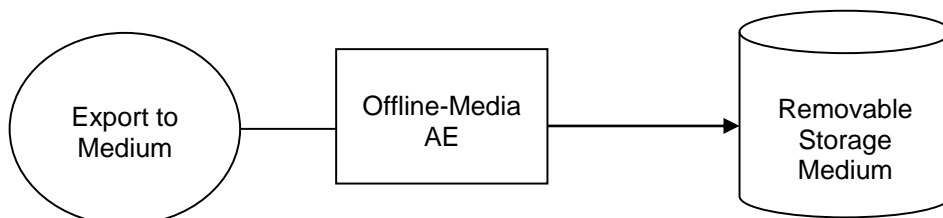

Figure A.4.1-1

APPLICATION DATA FLOW DIAGRAM FOR MEDIA STORAGE

- The Offline-Media Application Entity exports images (single or multiframe, a set of marked images, a whole patient folder or a set of patient folders – only Vision) to a floppy (not Vision), a MOD, a CD-R, DVD (only Vision) and USB Storage medium. It is associated with the local real-world activity Export <Medium Type>. The export is performed upon user request for the selected images. Maximum size of Multiframe is 2 Gbyte.

A.4.1.2 Functional Definition of AEs

A.4.1.2.1 Functional Definition of Offline-Media Application Entity

First the user has to set the format of the desired medium to "DICOM" or "DICOM 512x512 8bit" (Vision). On the MOSAIC-screen he can select a set of images and send the export job to the desired medium.

A.4.1.3 Sequencing of Real-World Activities

At least one image must exist before Offline-Media Application Entity can be invoked. The operator must insert a new or not empty medium before invocation of the Offline-Media Application Entity. The Offline-Media Application first finds out the free space on the medium and compares it with the size of data to be written. Then Offline-Media Application starts to write on the medium, exception: CD-R and DVD – the data are collected in a mirror-directory and burned after user confirmation.

A.4.1.4 File Meta Information Options

The implementation information written to the File Meta header in each file is see Table 4.2-3.

A.4.2 AE SPECIFICATION

A.4.2.1 Offline-Media Application Entity Specification

The Offline-Media Application Entity provides standard conformance to the DICOM Interchange Option of the Media Storage Service Class. The Application Profiles and roles are listed below:

**Table A.4.2-1
APPLICATION PROFILES, ACTIVITIES AND ROLES FOR OFFLINE-MEDIA**

Application Profiles Supported	Real World Activity	FSC/FSU on device	FSR on device	SC Option
STD-GEN-CD	Export/Import CD-R	all	all	Interchange
STD-XA1K-CD	Export/Import CD-R	Vision	Vision	Interchange
STD-GEN-DVD	Export/Import to DVD	Vision	Vision	Interchange
STD-GEN-USB	Export/Import to USB-Stick	Vision V2-0.5K	Vision V2-0.5K	Interchange
FLOP (only DOS)	Export/Import Floppy-Disk 1.44MB	Vista	Vista	Interchange
MOD650 (only DOS)	Export/Import MOD 650MB	all	all	Interchange

A.4.2.1.1 File Meta Information for the Application Entity

The Source Application Entity included in the File Meta Header is configurable (see section 5.4).

A.4.2.1.2 Real World Activities

A.4.2.1.2.1 Activity – Export to Medium and Import from Medium

The Offline-Media Application Entity acts as an FSC and FSR using the interchange option when requested to export SOP Instances from and to the local database.

Acting as an FSC the selected images and the corresponding DICOMDIR will be written together to the desired medium, multisession is supported. As an optional feature a DICOM viewer is burned on the CD, DVD or written on USB-Stick. The Ziehm Vision also writes a file README.TXT.

Acting as an FSR the contents of DICOMDIR will be displayed, the user steps through the whole DICOM information model STUDY, SERIES and IMAGE. At last it shows the image on the monitor (see DICOM Query/Retrieve MOVE). It only supports uncompressed Transfer Syntaxes (Little Endian). On the device Vision the contents of the whole Medium is displayed without user interaction!

A.4.2.1.2.1.1 Media Storage Application Profiles

The Offline-Media Application Entity supports the Application Profiles listed in Table A.4.2-1.

A.4.2.1.2.1.1.1 Options

The Offline-Media Application Entity supports the SOP Classes and Transfer Syntaxes listed in the table below:

Table A.4.2-2
IODS, SOP CLASSES AND TRANSFER SYNTAXES FOR OFFLINEMEDIA

Information Object Definition	SOP Class UID	Transfer Syntax	Transfer Syntax UID
Media Storage Directory Storage	1.2.840.10008.1.3.10	DICOM Explicit VR Little Endian	1.2.840.10008.1.2.1
Computed Radiography Image Storage	1.2.840.10008.5.1.4.1.1.1	DICOM Explicit VR Little Endian	1.2.840.10008.1.2.1
X-ray Angiographic Image Storage	1.2.840.10008.5.1.4.1.1.12.1	DICOM Explicit VR Little Endian	1.2.840.10008.1.2.1
Secondary Capture Image Storage	1.2.840.10008.5.1.4.1.1.7	DICOM Explicit VR Little Endian	1.2.840.10008.1.2.1
RT Image Storage	1.2.840.10008.5.1.4.1.1.481.1	DICOM Explicit VR Little Endian	1.2.840.10008.1.2.1
Digital X-ray Image Storage for Presentation (Vario 3D only)	1.2.840.10008.5.1.4.1.1.1.1	DICOM Explicit VR Little Endian	1.2.840.10008.1.2.1
CT Image Storage (Vario 3D and RFD 3D)	1.2.840.10008.5.1.4.1.1.2	DICOM Explicit VR Little Endian	1.2.840.10008.1.2.1
FSR: all other SOP Classes See table: A.4.2-18			

A.4.3 AUGMENTED AND PRIVATE APPLICATION PROFILES

No private application profiles are supported.

A.4.4 MEDIA CONFIGURATION

All local applications use AE Title configured in the service dialog.

A.5 SUPPORT OF CHARACTER SETS

The Ziehm NetPort DICOM applications support the following character sets:

ISO_IR 100	Latin Alphabet No. 1 supplementary set of ISO 8859
ISO_IR 101	Latin Alphabet No. 2 supplementary set of ISO 8859
ISO_IR 144	Cyrillic, supplementary set of ISO 8859 (only Vision)
ISO_IR 148	Latin Alphabet No. 5 supplementary set of ISO 8859 (only Vision)
ISO_IR 192	UTF8 (as from Software Version 7.04ff)
ISO 2022 IR 87	ISO 2022-JP

Used specific character set in SOP Common module is automatically filled by the system but depends on the language setting of the system.

The following tables provide an informative mapping of system language values to supported Specific Character Set

- Image IODs

	ISO_IR 100	ISO_IR 101	ISO_IR 148	ISO_IR 192	ISO 2022 IR 87
Polish		X			
Hungarian		X			
Turkish			X		
Russian				X	
Japanese					X
Others	X				

- Document SR IODs

Up to SW 7.08:

	ISO_IR 100	ISO_IR 101	ISO_IR 148	ISO_IR 192	ISO 2022 IR 87
Polish				X	
Hungarian				X	
Turkish				X	
Russian				X	
Japanese				X	
Others				X	

SW 7.08.1 and above:

	ISO_IR 100	ISO_IR 101	ISO_IR 148	ISO_IR 192	ISO 2022 IR 87
Polish		X		X	
Hungarian		X		X	
Turkish			X	X	
Russian				X	
Japanese				X	X
Others	X			X	

The use of ISO_IR 192 (Unicode character set) or Language specific character is configurable by the user.

A.6 SECURITY

The Ziehm NetPort does not support any specific security measures.

It is assumed that the Ziehm NetPort is used within a secured environment. It is assumed that a secured environment includes at a minimum:

- a. Firewall or router protections to ensure that only approved external hosts have network access to Ziehm NetPort.
- b. Firewall or router protections to ensure that Ziehm NetPort only has network access to approved external hosts and services.
- c. Any communication with external hosts and services outside the locally secured environment use appropriate secure network channels.
- d. That configuration parameters are changed by technical specialists with due diligence, in particular with registered port numbers, twice distributed IP addresses.

A.7 ANNEXES

A.7.1 IOD CONTENTS

A.7.1.1 Created SOP Instances

The following tables use a number of abbreviations. The abbreviations used in the "Presence of" column are:

VNAP Value Not Always Present
 ANAP Attribute Not Always Present
 ALWAYS Always Present
 EMPTY

The abbreviations used in the "Source .." column are:

MWL Attribute from Modality Worklist
 USER Attribute from User input
 AUTO Attribute generated automatically
 CONFIG Attribute from configurable parameter

A.7.1.1.1 X-ray Angiographic Image IOD

Table A.7.1-1
IOD OF CREATED XA/XRF SOP INSTANCES

IE	Module	Reference	Presence of Module
Patient	Patient	Table 7.1-6	ALWAYS
Study	General Study	Table 7.1-7	ALWAYS
Series	General Series	Table 7.1-8	ALWAYS
Equipment	General Equipment	Table 7.1-10	ALWAYS
Image	General Image	Table 7.1-12	ALWAYS
	Image Pixel	Table 7.1-13	ALWAYS
	Cine	Table 7.1-14	Only if Multiframe
	Multi-Frame	Table 7.1-15	Only if Multiframe
	Mask	Table 7.1-16	ALWAYS
	Display Shutter	Table 7.1- 43	ALWAYS
	X-ray Image	Table 7.1-17	ALWAYS
	X-ray Acquisition	Table 7.1-18	ALWAYS
	X-ray Collimator	Table 7.1-19	ALWAYS
	XA/XRF Positioner	Table 7.1-35	ALWAYS
	VOI LUT	Table 7.1-29	ALWAYS
	SOP Common	Table 7.1-30	ALWAYS

A.7.1.1.2 Computed Radiography Image IOD

Table A.7.1-2

IOD OF CREATED CR SOP INSTANCES

IE	Module	Reference	Presence of Module
Patient	Patient	Table 7.1-6	ALWAYS
Study	General Study	Table 7.1-7	ALWAYS
Series	General Series	Table 7.1-8	ALWAYS
	CR Series	Table 7.1-20	
Equipment	General Equipment	Table 7.1-10	ALWAYS
Image	General Image	Table 7.1-12	ALWAYS
	Image Pixel	Table 7.1-13	ALWAYS
	CR Image	Table 7.1-21	ALWAYS
	Display Shutter	Table 7.1- 43	ALWAYS
	VOI LUT	Table 7.1-29	ALWAYS
	SOP Common	Table 7.1-30	ALWAYS

A.7.1.1.3 Secondary Capture Image IOD

Table A.7.1-3

IOD OF CREATED OT SOP INSTANCES

IE	Module	Reference	Presence of Module
Patient	Patient	Table 7.1-6	ALWAYS
Study	General Study	Table 7.1-7	ALWAYS
Series	General Series	Table 7.1-8	ALWAYS
Equipment	General Equipment	Table 7.1-10	ALWAYS
	SC Equipment	Table 7.1-11	ALWAYS
Image	General Image	Table 7.1-12	ALWAYS
	Image Pixel	Table 7.1-13	ALWAYS
	SC Image	Table 7.1-22	ALWAYS
	VOI LUT	Table 7.1-29	ALWAYS
		SOP Common	Table 7.1-30

A.7.1.1.4 Digital X-ray Image IOD

Table A.7.1-4

IOD OF CREATED DX SOP INSTANCES

IE	Module	Reference	Presence of Module
Patient	Patient	Table 7.1-6	ALWAYS
Study	General Study	Table 7.1-7	ALWAYS
Series	General Series	Table 7.1-8	ALWAYS
	DX Series	Table 7.1-9	
Equipment	General Equipment	Table 7.1-10	ALWAYS
Image	General Image	Table 7.1-12	ALWAYS
	Image Pixel	Table 7.1-13	ALWAYS
	DX Anatomy Imaged	Table 7.1-24	
	DX Image	Table 7.1-23	ALWAYS
	DX Detector	Table 7.1-25	
	VOI LUT	Table 7.1-29	ALWAYS
	Acquisition Context	Table 7.1.31	
		SOP Common	Table 7.1-30
	Private Application	Table 7.1-32	ALWAYS

A.7.1.1.5 COMPUTED TOMOGRAPHY Image IOD

Table A.7.1-5
IOD OF CREATED CT SOP INSTANCES

IE	Module	Reference	Presence of Module
Patient	Patient	Table 7.1-6	ALWAYS
Study	General Study	Table 7.1-7	ALWAYS
Series	General Series	Table 7.1-8	ALWAYS
Frame of Reference	Frame of Reference	Table 7.1-26	ALWAYS
Equipment	General Equipment	Table 7.1-10	ALWAYS
Image	General Image	Table 7.1-12	ALWAYS
	Image Plane	Table 7.1-27	
	Image Pixel	Table 7.1-13	ALWAYS
	CT Image	Table 7.1-28	ALWAYS
	VOI LUT	Table 7.1-29	ALWAYS
	SOP Common	Table 7.1-30	ALWAYS

A.7.1.1.6 RT Image IOD

Table A.7.1-36
IOD OF CREATED RT IMAGE SOP INSTANCES

IE	Module	Reference	Presence of Module
Patient	Patient	Table 7.1-6	ALWAYS
Study	General Study	Table 7.1-7	ALWAYS
Series	General Series	Table 7.1-8	ALWAYS
Equipment	General Equipment	Table 7.1-10	ALWAYS
Image	General Image	Table 7.1-12	ALWAYS
	Image Pixel	Table 7.1-13	ALWAYS
	Cine	Table 7.1-14	Only if Multiframe
	Multi-Frame	Table 7.1-15	Only if Multiframe
	Mask	Table 7.1-16	ALWAYS
	RT Image	Table 7.1-37	ALWAYS
	VOI LUT	Table 7.1-29	ALWAYS
	SOP Common	Table 7.1-30	ALWAYS

A.7.1.1.7 X-ray Radiation Dose SR IOD

Table A.7.1-38
IOD OF CREATED DOSE SR SOP INSTANCES

IE	Module	Reference	Presence of Module
Patient	Patient	Table 7.1-6	ALWAYS
Study	General Study	Table 7.1-7	ALWAYS
Series	SR Document Series	Table 7.1-39	ALWAYS
Equipment	General Equipment	Table 7.1-10	ALWAYS
	Enhanced General Equipment	Table 7.1-40	ALWAYS
Document	SR Document General	Table 7.1-41	ALWAYS
	SR Document Content	Table 7.1-42	ALWAYS
	SOP Common	Table 7.1-30	ALWAYS

A.7.1.1.8 Common Modules

Table A.7.1-6

PATIENT MODULE OF CREATED SOP INSTANCES

Attributes Name	Tag	VR	Value	Presence of Value	Source
Patient's Name	(0010,0010)	PN	See *) Max 64 char	VNAP	MWL,Query,User
Patient ID	(0010,0020)	LO	Max 64 char	ALWAYS	MWL,User
Patient's Birth Date	(0010,0030)	DA	Default value if not present	ALWAYS	MWL,Query,User
Patient's Sex	(0010,0040)	CS	M,F,O,<empty string>	ALWAYS	MWL,Query,User

*) Family^Given^Middle^Prefix^Suffix if sent via DICOM Worklist

Table A.7.1-7

GENERAL STUDY MODULE OF CREATED SOP INSTANCES

Attributes Name	Tag	VR	Value	Presence of Value	Source
Study Instance UID	(0020,000D)	UI	See 1)	ALWAYS	MWL,AUTO
Study Date	(0008,0020)	DA	<yyyymmdd>	ALWAYS	Creation Date of patient folder
Study Time	(0008,0030)	TM	<hhmmss>	ALWAYS	Creation Time of patient folder
Referring Physician's Name	(0008,0090)	PN	From Worklist	VNAP	MWL
Requesting Physician	(0032,1032)	PN	From Worklist	VNAP	MWL
Study ID	(0020,0010)	SH	Req.Proc. ID	VNAP	MWL
Accession Number	(0008,0050)	SH		VNAP	MWL, Query or User input
Study Description	(0008,1030)	LO	Subject from dialog or Scheduled Procedure Step Description With SW 6.00ff: Requested Procedure Description	VNAP	MWL, User input
Ref. Study Sequence	(0008,1110)	SQ	From Worklist	VNAP	MWL
> Ref. SOP Class UID	(0008,1150)	UI			
> Ref. SOP Instance UID	(0008,1155)	UI			

Table A.7.1-8

GENERAL SERIES MODULE OF CREATED SOP INSTANCES

Attributes Name	Tag	VR	Value	Presence of Value	Source
Modality	(0008,0060)	CS	XA,CR,OT,DX,CT,RTIMAGE	ALWAYS	AUTO
Series Instance UID	(0020,000E)	UI	See 1)	ALWAYS	AUTO 1) 2)
Series Number	(0020,0011)	IS	1	ALWAYS	AUTO 2)
Series Date	(0008,0021)	DA	<yyyymmdd>	ALWAYS	Same as Study Date
Performing Physician's Name	(0008,1050)	PN		VNAP	User input
Protocol Name	(0018,1030)	LO	With MPPS	VNAP	MWL
Series Description	(0008,103E)	LO	Scheduled Procedure Step Description	VNAP	MWL or copy of (0008,1030)
Operator's Name	(0008,1070)	PN	Only family name	VNAP	From Configuration
Ref. Study Comp. Seq.	(0008,1111)	SQ	From MPPS	VNAP	

Attributes Name	Tag	VR	Value	Presence of Value	Source
> Ref. SOP Class UID	(0008,1150)	UI	1.2.840.10008.3.1.2.3.3	VNAP	If MPPS is created
> Ref. SOP Instance UID	(0008,1155)	UI	<MPPS UID>	VNAP	
Patient Position	(0018,5100)	CS	HFS, ...	ANAP	CT and RT Image only, from 3D workstation
Request Attribute Seq.	(0040,0275)	SQ	From Worklist	VNAP	AUTO
>Req. Proc. ID	(0040,1001)	SH	From Worklist	VNAP	MWL
>Sched Proc. Step ID	(0040,0009)	SH	From Worklist	VNAP	MWL
>Sched Proc. Step Desc.	(0040,0007)	LO	From Worklist	VNAP	MWL
>Sched Prot.Code Seq	(0040,0008)	SQ	From Worklist	VNAP	MWL
>> code sequence Perf. Proc Step Start Date	(0040,0244)	DA	<yyyymmdd>	ALWAYS	See A.4.2-25 AUTO, see Study Date
Perf. Proc Step Start Time	(0040,0245)	TM	<hhmmss>	ALWAYS	AUTO, see Study Time
Perf. Proc. Step ID	(0040,0253)	SH		ALWAYS	AUTO or input 2)

- 1) Overwriting of patient family name, first name or ID causes creation of new Study Instance UID, Series Instance UID and SOP Instance UID
- 2) Input of Tag (0040,0253) on Vision only, causes creation of a new Series (UID and Number)

RTIMAGE Series does not export Protocol Name, Requested Attribute Sequence and Performed Procedure Data

Table A.7.1-9
DX SERIES MODULE OF CREATED SOP INSTANCES

Attributes Name	Tag	VR	Value	Presence of Value	Source
Modality	(0008,0060)	CS	DX	ALWAYS	AUTO
Presentation Intent Type	(0008,0068)	CS	FOR PRESENTATION	ALWAYS	AUTO

Table A.7.1-10
GENERAL EQUIPMENT MODULE OF CREATED SOP INSTANCES

Attributes Name	Tag	VR	Value	Presence of Value	Source
Manufacturer	(0008,0070)	LO	Ziehm Imaging	ALWAYS	AUTO
Institution Name	(0008,0080)	LO	From Hospital	VNAP	User input
Institution Address	(0008,0081)	ST	Address of Hospital	ANAP	Worklist
Station Name	(0008,1010)	SH	<AE Title Ziehm NetPort>	ALWAYS	CONFIG
Manufacturer's Model Name	(0008,1090)	LO	Ziehm NetPort With SW 6.00ff: Ziehm model names	ALWAYS	AUTO
Device Serial Number	(0018,1000)	LO	<Serial Number of device>	ALWAYS	AUTO
Software Version	(0018,1020)	LO	<SW-Version>\<SYS-Version>	ALWAYS	AUTO

Table A.7.1-11
SC EQUIPMENT MODULE OF CREATED SOP INSTANCES

Attributes Name	Tag	VR	Value	Presence of Value	Source
Conversion Type	(0008,0064)	LO	DI	ALWAYS	AUTO

Table A.7.1-12
GENERAL IMAGE MODULE OF CREATED SOP INSTANCES

Attributes Name	Tag	VR	Value	Presence of Value	Source
Instance Number	(0020,0013)	IS	Generated by device	ALWAYS	AUTO
Patient Orientation	(0020,0020)	CS	R/F default	ALWAYS	User can change
Content Date	(0008,0023)	DA	Generated by device (changed by PostProcess, clean up cine loop)	ALWAYS	AUTO
Content Time	(0008,0033)	TM	Generated by device (see Content Date)	ALWAYS	AUTO
Acquisition Date	(0008,0022)	DA	Generated by device (never changed)	ALWAYS	AUTO
Acquisition Time	(0008,0032)	TM	Generated by device (never changed)	ALWAYS	AUTO
Image Comments	(0020,4000)	LT	From Notice	VNAP	User input
Irradiation Event UID	(0008,3010)	UI	If DicomDoseSR can be sent	ANAP	AUTO

Table A.7.1-13
IMAGE PIXEL MODULE OF CREATED SOP INSTANCES

Attributes Name	Tag	VR	Value	Presence of Value	Source
Samples per Pixel	(0028,0002)	US	1	ALWAYS	AUTO
Photometric Interpretation	(0028,0004)	CS	MONOCHROME2	ALWAYS	AUTO
Rows	(0028,0010)	US	576 or 1024	ALWAYS	AUTO
Columns	(0028,0011)	US	576 or 1024	ALWAYS	AUTO
Bits Allocated	(0028,0100)	US	8 or 16	ALWAYS	AUTO
Bits Stored	(0028,0101)	US	8 or 10 or 16	ALWAYS	AUTO
High Bit	(0028,0102)	US	7 or 9 or 15	ALWAYS	AUTO
Pixel Representation	(0028,0103)	US	0	ALWAYS	AUTO
Lossy Compression	(0028,2110)	CS	00	ALWAYS	AUTO
Quality Control Image	(0028,0300)	CS	YES	ANAP	If image is TestPattern
Pixel Data	(7FE0,0010)	OB / OW	OB for Bits allocated 8 OW for Bits allocated 16	ALWAYS	AUTO
Smallest Image Pixel Value	(0028,0106)	US	0	ALWAYS	AUTO
Largest Images Pixel Value	(0028,0107)	US	2^bitsStored	ALWAYS	AUTO

Table A.7.1-14
CINE MODULE OF CREATED XA SOP INSTANCES

Attributes Name	Tag	VR	Value	Presence of Value	Source
Frame Time	(0018,1063)	DS	If multiframe	ANAP	AUTO
Cine Rate	(0018,0040)	IS	If multiframe	ANAP	User selects

Table A.7.1-15

MULTI-FRAME MODULE OF CREATED XA SOP INSTANCES

Attributes Name	Tag	VR	Value	Presence of Value	Source
Number of Frames	(0028,0008)	IS	If multiframe	ANAP	AUTO
Frame Increment Pointer	(0028,0009)	AT	Pointer to 0018,1063	ANAP	AUTO

Table A.7.1-16

MASK MODULE OF CREATED XA SOP INSTANCES

Attributes Name	Tag	VR	Value	Presence of Value	Source
Mask Subtraction Sequence	(0028,6100)	SQ	If multiframe	ALWAYS	AUTO
>Mask Operation	(0028,6101)	CS	NONE	ALWAYS	AUTO
Recommended Viewing Mode	(0028,1090)	CS	NAT	ALWAYS	AUTO

Table A.7.1-17

X-RAY IMAGE MODULE OF CREATED XA SOP INSTANCES

Attributes Name	Tag	VR	Value	Presence of Value	Source
Frame Increment Pointer	(0028,0009)	AT		ANAP	AUTO
Image Type	(0008,0008)	CS	ORIGINAL\PRIMARY\SINGLE PLANE (acquired images) or DERIVED\PRIMARY\SINGLE PLANE (post-processed images) \DSA, \MSA, \RSA (for DSA, MSA, RSA images) \FLAT (if flat detector) or ..\MEASUREMENT	ALWAYS	AUTO
Pixel Intensity Relationship	(0028,1040)	CS	LIN	ALWAYS	AUTO
Samples per Pixel	(0028,0002)	US	1	ALWAYS	AUTO
Photometric Interpretation	(0028,0004)	CS	MONOCHROME2	ALWAYS	AUTO
Rows	(0028,0010)	US	576 or 1024/512	ALWAYS	AUTO
Columns	(0028,0011)	US	576 or 1024/512	ALWAYS	AUTO
Bits Allocated	(0028,0100)	US	8 or 16	ALWAYS	AUTO
Bits Stored	(0028,0101)	US	8 or 10 or 16	ALWAYS	AUTO
High Bit	(0028,0102)	US	7 or 9 or 15	ALWAYS	AUTO
Pixel Representation	(0028,0103)	US	0	ALWAYS	AUTO
Scan Options	(0018,0022)	CS	ROTA	ANAP	If image is IsoCine
Derivation Description	(0008,2111)	ST	Data from post processing	ANAP	AUTO
Acquisition Device Processing Description	(0018,1400)	LO	Data from post processing	ANAP	AUTO

Table A.7.1-18

X-RAY ACQUISITION MODULE OF CREATED XA SOP INSTANCES

Attributes Name	Tag	VR	Value	Presence of Value	Source
KVP	(0018,0060)	DS	From Acquisition parameters	ALWAYS	AUTO
Field of View Shape	(0018,1147)	CS	RECTANGLE	ALWAYS	VISION

Attributes Name	Tag	VR	Value	Presence of Value	Source
			ROUND		FLAT OTHERS
Radiation Setting	(0018,1155)	CS	SC or GR	ALWAYS	AUTO
X-ray Tube Current	(0018,1151)	IS	In milliamperes (mA)	ALWAYS	AUTO
Type of filters	(0018,1161)	LO	4.5 mm Al + 0.1 mm Cu 6.5 mm Al + 0.1 mm Cu for 110 kV devices: >= 3.9 mm Al + 0.1 mm Cu for 120 kV devices: >= 4.3 mm Al + 0.1 mm Cu for all others: 5 mm Al	ALWAYS	VISTA VISION VISION FLAT VISION R
Grid	(0018,1166)	CS	IN or NONE	ALWAYS	AUTO
Intensifier Size	(0018,1162)	DS	Size of Image Intensifier in mm	ANAP	AUTO
Radiation Mode	(0018,115A)	CS	PULSED (Vision) CONTINUOUS (Vista)	ALWAYS	AUTO
Exposure Time	(0018,1150)	IS	Duration of X-ray in msec	ALWAYS	AUTO
Image Area Dose Product	(0018,115E)	DS	X-ray dose in dGy*cm*cm for this image	ALWAYS	AUTO
Comments on Radiation Dose	(0040,0310)	ST	Measured or Calculated	ALWAYS	AUTO
Focal Spots	(0018,1190)	DS	0.6 or 0.3 depends on filament	ALWAYS	AUTO
Pixel Spacing	(0028,0030)	DS	Calculated from user input	ANAP	AUTO
Pixel Spacing Calibration Type	(0028,0A02)	CS	FIDUCIAL	ANAP	AUTO
Pixel Spacing Calibration Description	(0028,0A04)	LO	Calibration done by Image PostProcessing	ANAP	AUTO

Table A.7.1-19

X-RAY COLLIMATOR MODULE OF CREATED XA SOP INSTANCES

Attributes Name	Tag	VR	Value	Presence of Value	Source
Collimator Shape	(0018,1700)	CS	RECTANGULAR CIRCULAR POLYGONAL	ALWAYS	VISION FLAT OTHERS VISION (SW5.25)
Center of Circular Collimator	(0018,1710)	IS	287\287 or 511\511	ALWAYS	Not VISION FLAT
Radius of Circular Collimator	(0018,1712)	IS	288 or 512	ALWAYS	Not VISION FLAT
Collimator Left Vertical Edge	(0018,1702)	IS	0	ALWAYS	VISION FLAT
Collimator Right Vertical Edge	(0018,1704)	IS	1023	ALWAYS	VISION FLAT
Collimator Upper Horizontal Edge	(0018,1706)	IS	0	ALWAYS	VISION FLAT
Collimator Lower Horizontal Edge	(0018,1708)	IS	1023	ALWAYS	VISION FLAT
Vertices of the Polygonal Collimator	(0018,1720)	IS	<row,column>\....	ALWAYS	VISION (SW5.25)

Table A.7.1-20

CR SERIES MODULE OF CREATED CR SOP INSTANCES

Attributes Name	Tag	VR	Value	Presence of Value	Source
View Position	(0018,5101)	CS	Zero Length	ALWAYS	AUTO

Attributes Name	Tag	VR	Value	Presence of Value	Source
Focal Spots	(0018,1190)	DS	0.6 or 0.3	ALWAYS	AUTO

Table A.7.1-21

CR IMAGE MODULE OF CREATED CR SOP INSTANCES

Attributes Name	Tag	VR	Value	Presence of Value	Source
KVP	(0018,0060)	DS	From Acquisition parameters	ALWAYS	AUTO
X-ray Tube Current	(0018,1151)	IS	In milliamperes (mA)	ALWAYS	AUTO
Distance Source to Detector	(0018,1110)	DS	970 Vision Vista 1110 Vision FD	ALWAYS	AUTO
Acquisition Device Processing Description	(0018,1400)	LO	Data from post processing	ANAP	AUTO

Pixel Spacing- Attributes see Table A 7.1.-18

Table A.7.1-22

SC IMAGE MODULE ATTRIBUTES

Attributes Name	Tag	VR	Value	Presence of Value	Source
	-	-	-	-	-

Pixel Spacing- Attributes see Table A 7.1.-18

Table A.7.1-23

DX IMAGE MODULE ATTRIBUTES

Attributes Name	Tag	VR	Value	Presence of Value	Source
Image Type	(0008,0008)	CS	ORIGINALPRIMARY	ALWAYS	AUTO
Pixel Intensity Relationship	(0028,1040)	CS	LIN	ALWAYS	AUTO
Pixel Intensity Relationship Sign	(0028,1041)	SS	-1	ALWAYS	AUTO
Samples per Pixel	(0028,0002)	US	1	ALWAYS	AUTO
Photometric Interpretation	(0028,0004)	CS	MONOCHROME2	ALWAYS	AUTO
Rows	(0028,0010)	US	568	ALWAYS	AUTO
Columns	(0028,0011)	US	568	ALWAYS	AUTO
Bits Allocated	(0028,0100)	US	8	ALWAYS	AUTO
Bits Stored	(0028,0101)	US	8	ALWAYS	AUTO
High Bit	(0028,0102)	US	7	ALWAYS	AUTO
Pixel Representation	(0028,0103)	US	0	ALWAYS	AUTO
Rescale Intercept	(0028,1052)	DS	0	ALWAYS	AUTO
Rescale Slope	(0028,1053)	DS	1	ALWAYS	AUTO
Rescale Type	(0028,1054)	LO	US	ALWAYS	AUTO
Presentation LUT Shape	(2050,0020)	CS	IDENTITY	ALWAYS	AUTO
Lossy Image Compression	(0028,2110)	CS	0	ALWAYS	AUTO
Patient Orientation	(0020,0020)	CS	LH	ALWAYS	AUTO
Burned in Annotation	(0028,0301)	CS	20302	ALWAYS	AUTO
Window Center	(0028,1050)	DS	128	ALWAYS	User input
Window width	(0028,1051)	DS	256	ALWAYS	User input

DX Images are Projection images for Vario 3D and support private tags for construction of 3D Images.

Table A.7.1-24
DX ANATOMY IMAGED MODULE ATTRIBUTES

Attributes Name	Tag	VR	Value	Presence of Value	Source
Anatomic Region Sequence	(0008,2218)	SQ	-	EMPTY	AUTO
Image Laterality	(0020,0062)	CS	U	ALWAYS	AUTO

Table A.7.1-25
DX DETECTOR MODULE ATTRIBUTES

Attributes Name	Tag	VR	Value	Presence of Value	Source
Detector Type	(0018,7004)	CS	SCINTILLATOR	ALWAYS	AUTO

Table A.7.1-26
FRAME OF REFERENCE MODULE ATTRIBUTES (CT and RT SOP INSTANCES)

Attributes Name	Tag	VR	Value	Presence of Value	Source
Frame of Reference UID	(0020,0052)	UI	Image UID	ALWAYS from SW7.07	3D workstation
Position Reference Indicator	(0020,1040)	LO	<empty>	ALWAYS	3D workstation

Table A.7.1-27
IMAGE PLANE MODULE ATTRIBUTES (CT SOP INSTANCES)

Attributes Name	Tag	VR	Value	Presence of Value	Source
Pixel Spacing	(0028,0030)	DS	2.000\2.000	ALWAYS	3D workstation
Image Position (Patient)	(0020,0032)	DS	0.0\0.0\0.0	ALWAYS	3D workstation
Image Orientation (Patient)	(0020,0037)	DS	1\0\1\0\1\0	ALWAYS	3D workstation
Slice Thickness	(0018,0050)	DS	2	ALWAYS	3D workstation

Table A.7.1-28
CT IMAGE MODULE ATTRIBUTES

Attributes Name	Tag	VR	Value	Presence of Value	Source
Image Type	(0008,0008)	CS	DERIVED\PRIMARY\AXIAL	ALWAYS	AUTO
Pixel Intensity Relationship	(0028,1040)	CS	LIN	ALWAYS	AUTO
Samples per Pixel	(0028,0002)	US	1	ALWAYS	AUTO
Photometric Interpretation	(0028,0004)	CS	MONOCHROME2	ALWAYS	AUTO
Rows	(0028,0010)	US	256, 320 or 512	ALWAYS	User input
Columns	(0028,0011)	US	256, 320 or 512	ALWAYS	User input
Bits Allocated	(0028,0100)	US	16	ALWAYS	AUTO
Bits Stored	(0028,0101)	US	16	ALWAYS	AUTO
High Bit	(0028,0102)	US	15	ALWAYS	AUTO
Rescale Intercept	(0028,1052)	DS	0	ALWAYS	3D workstation
Rescale Slope	(0028,1053)	DS	1	ALWAYS	3D workstation
Rescale Type	(0028,1054)	LO	US	ALWAYS	AUTO

Table A.7.1-29

VOI LUT TABLE MODULE ATTRIBUTES

Attributes Name	Tag	VR	Value	Presence of Value	Source
Window Center	(0028,1050)	DS	0..2 ⁿ bitsStored	ALWAYS	User input
Window Width	(0028,1051)	DS	1..2 ⁿ bitsStored	ALWAYS	User input
Window Center & Width Explanation	(0028,1055)	LO	[C-W/2; C+W/2] ⇔ [0;1024] {x y=(1024/W)*(x-C+W/2)}	ALWAYS	AUTO
VOI LUT Function	(0028,1056)	CS	LINEAR	Pixel data with DICOM - LUT	AUTO

Table A.7.1-30

SOP COMMON MODULE ATTRIBUTES

Attributes Name	Tag	VR	Value	Presence of Value	Source
Specific Character Set	(0008,0005)	CS	See A.5	ALWAYS	AUTO
SOP Class UID	(0008,0016)	UI	See Table A.3.2-1	ALWAYS	AUTO
SOP Instance UID	(0008,0018)	UI	Generated by device	ALWAYS	AUTO

Table A.7.1-31

AQUISITION CONTEXT MODULE ATTRIBUTES (DX SOP INSTANCES)

Attributes Name	Tag	VR	Value	Presence of Value	Source
-----------------	-----	----	-------	-------------------	--------

Table A.7.1-35

XA/XRF POSITIONER MODULE ATTRIBUTES

Attributes Name	Tag	VR	Value	Presence of Value	Source
Distance Source To Detector	(0018,1110)	CS	970 Vision Vista 1110 Vision FD	ALWAYS for XA and XRF	AUTO
Positioner Motion	(0018,1500)	CS	STATIC if system is not motorized	ALWAYS for XA SW 7.08.1 and above	AUTO
			STATIC for single frame image or multi-frame image without motion		
			DYNAMIC for multi-frame image with motion		
Positioner Primary Angle	(0018,1510)	DS	If system is not motorized: <empty>	ALWAYS for XA SW 7.08.1 and above	AUTO
			If system is motorized and Positioner Motion is STATIC: RAO/LAO Angle		
			If system is motorized and Positioner Motion is DYNAMIC: 0°		

Positioner Secondary Angle	(0018,1511)	DS	If system is not motorized: <empty>	ALWAYS for XA SW 7.08.1 and above	AUTO
			If system is motorized and Positioner Motion is STATIC: RAO/LAO Angle		
			If system is motorized and Positioner Motion is DYNAMIC: 0°		
Positioner Primary Angle Increment	(0018,1520)	DS	Vector of the absolute positioner CRA/CAU angles	ALWAYS for XA but only if the system is motorized and Positioner motion is DYNAMIC SW 7.08.1 and above	AUTO
Positioner Secondary Angle Increment	(0018,1521)	DS	Vector of the absolute positioner CRA/CAU angles	ALWAYS for XA but only if the system is motorized and Positioner motion is DYNAMIC SW 7.08.1 and above	AUTO

If the system detects invalid values during vector generation for attribute (0018,1520) and/or (0018,1521), these attributes will be present in the dataset but the corresponding value will be empty.

Table A.7.1-37

RT IMAGE MODULE OF CREATED RT SOP INSTANCES (not Vista)

Attributes Name	Tag	VR	Value	Presence of Value	Source
Image Type	(0008,0008)	CS	ORIGINAL\PRIMARY\ DRR (if not downsized) DERIVED\PRIMARY\ DRR (downsized)	ALWAYS	AUTO
Samples per Pixel	(0028,0002)	US	1	ALWAYS	AUTO
Photometric Interpretation	(0028,0004)	CS	MONOCHROME2	ALWAYS	AUTO
Rows	(0028,0010)	US	1024/512	ALWAYS	AUTO
Columns	(0028,0011)	US	1024/512	ALWAYS	AUTO
Bits Allocated	(0028,0100)	US	8 or 16	ALWAYS	AUTO
Bits Stored	(0028,0101)	US	8 or 10/16	ALWAYS	AUTO
High Bit	(0028,0102)	US	7 or 9/15	ALWAYS	AUTO
Pixel Representation	(0028,0103)	US	0	ALWAYS	AUTO
RT Image Label	(3002,0002)	SH	Vario 3D rsp. RFD 3D	ALWAYS	AUTO
Conversion Type	(0008,0064)	CS	DI	ALWAYS	AUTO
RT Image Plane	(3002,000C)	CS	NORMAL	ALWAYS	AUTO
XRayImageReceptorTranslation	(3002,000D)	DS	-2.997192\6.735398\ -398.8463	ALWAYS	3D workstation
X-ray Image Receptor Angle	(3002,000E)	DS	Rotation angle of image	ALWAYS	AUTO
Image Plane Pixel Spacing	(3002,0011)	DS	<Depends on unit and MagMode>	ALWAYS	AUTO
RT Image Position	(3002,0012)	DS	From 3D workstation	ALWAYS	AUTO
Radiation Machine Name	(3002,0020)	SH	VARIO rsp. RFD 3D	ALWAYS	AUTO
Primary Dosimeter Unit	(300A,00B3)	CS	MINUTE	ALWAYS	AUTO
Radiation Machine SAD	(3002,0022)	DS	From 3D workstation	VNAP	AUTO
RT Image SID	(3002,0026)	DS	See (0018,1110) in XA Image	ALWAYS	AUTO
Exposure Sequence	(3002,0030)	SQ		ALWAYS	AUTO
>KVP	(0018,0060)	DS	See XA Image	ALWAYS	AUTO
>X-ray Tube Current	(0018,1151)	IS	See XA Image	ALWAYS	AUTO
>Number Of Blocks	(300A,00F0)	IS	0	ALWAYS	AUTO
Gantry Angle	(300A,011E)	DS	From 3D workstation	VNAP	AUTO

*) RT Image Position is marked by a burned-in-Crosshair in uncompressed images

Table A.7.1-39

SR DOCUMENT SERIES OF CREATED SR

Attributes Name	Tag	VR	Value	Presence of Value	Source
Modality	(0008,0060)	CS	SR	ALWAYS	AUTO
ReferencedPerformed-ProcedureStepSequence	(0008,1111)	SQ	Zero Length	ALWAYS	AUTO
Series Instance UID	(0020,000E)	UI	created by Ziehm Netport for every SR Instance	ALWAYS	AUTO
Series Number	(0020,0011)	IS	2	ALWAYS	AUTO

Table A.7.1-40
ENHANCED GENERAL EQUIPMENT OF CREATED SR

Attributes Name	Tag	VR	Value	Presence of Value	Source
Manufacturer	(0008,0070)	LO	Ziehm Imaging	ALWAYS	AUTO
Manufacturer Model Name	(0008,1090)	LO	Ziehm NetPort With SW 6.00ff: Ziehm model names With SW 7.04: Fujifilm model names	ALWAYS	AUTO
Device Serial Number	(0018,1000)	LO	see A 8.1-10	ALWAYS	AUTO
Software Versions	(0018,1020)	LO	see A 8.1-10	ALWAYS	AUTO

Table A.7.1-41
SR DOCUMENT GENERAL OF CREATED SR

Attributes Name	Tag	VR	Value	Presence of Value	Source
Instance Number	(0020,0013)	LO	1	ALWAYS	AUTO
Completion Flag	(0040,A491)	CS	COMPLETE	ALWAYS	AUTO
Verification Flag	(0040,A493)	CS	UNVERIFIED	ALWAYS	AUTO
Content Date	(0008,0023)	DA	Creation date	ALWAYS	AUTO
Content Time	(0008,0033)	TM	Creation time	ALWAYS	AUTO
Referenced Request Sequence	(0040,A370)	SQ		ALWAYS	AUTO
>Study Instance UID	(0020,000D)	UI	See A.7.7.1-7	ALWAYS	AUTO
>Referenced Study Sequence	(0008,1110)	SQ	See A.3.2-25	From Worklist	AUTO
>>ReferencedSOPClass	(0008,1150)	UI		From Worklist	AUTO
>>ReferencedSOPInstanceUID	(0008,1155)	UI		From Worklist	AUTO
>Accession Number	(0008,0050)	LO	See A.7.7.1-7	From Worklist or user input	AUTO
>Placer Order Number/Imaging Service Request	(0040,2016)	LO	<empty>		AUTO
>Filler Order Number/Imaging Service Request	(0040,2017)	LO	<empty>		AUTO
>Requested Procedure ID	(0040,1001)	SH	See A.3.2-25	From Worklist	AUTO
>Requested Procedure Description	(0032,1060)	LO	See A.3.2-25	From Worklist	AUTO
>Requested Procedure Code Sequence	(0032,1064)	SQ	See A.3.2-22	From Worklist	AUTO
>>Code Value	(0008,0100)	SH		From Worklist	AUTO
>>Coding Scheme Designer	(0008,0102)	SH		From Worklist	AUTO
>>Code Meaning	(0008,0104)	LO		From Worklist	AUTO
>Reason for the Requested Procedure	(0040,1002)	LO	See A.3.2-22	From Worklist	AUTO
Performed Procedure Code Sequence	(0040,A372)	SQ	From (0040,0260)	From Worklist	AUTO
>Code Value	(0008,0100)	SH		From Worklist	AUTO
>Coding Scheme Designer	(0008,0102)	SH		From Worklist	AUTO
>Code Meaning	(0008,0104)	LO		From Worklist	AUTO

Tables A.7.1-42

SR DOCUMENT CONTENT OF CREATED SR
TID 10001, TID 1002, TID 1003, TID 1004, TID 10002, TID 10003(AB), TID 10004, TID 10007

Abbreviations:

NL = Nesting Level

DTID = Defined Template Identifier

VT = Value Type

DCID = Defined Context Group Identifier

EV = Enumerated Value

TID = Template Identifier

DT = Defined Term

Table TID 10001 Projection Radiation X-ray

NL	Rel with Parent	VT	Concept Name	Value Set Constraint
		CONTAINER	EV (113701, DCM, "X-ray Radiation Dose Report")	Root Node
>	HAS CONCEPT MOD	CODE	EV (121058, DCM, "Procedure reported")	DT (113704, DCM, "Projection X-ray")
>>	HAS CONCEPT MOD	CODE	EV (363703001, SCT, "Has Intent")	"RT-408C3", SRT, "Diagnostic Intent"
>		INCLUDE	DTID 1002 "Observer Context"	See table TID 1002,1003,1004
>	HAS OBS CONTEXT	CODE	EV (113705, DCM, "Scope of Accumulation")	113016, DCM, "Performed Procedure Step" or 113014, DCM, "Study"
>>	HAS PROPERTIES	UIDREF	DCID 10001 "UID Types"	121126, DCM, "Performed Procedure Step SOP Instance UID" or 110180, DCM, "StudyInstance UID"
>	CONTAINS	INCLUDE	DTID 10002 "Accumulated X-ray Dose"	See table TID 10002
>	CONTAINS	INCLUDE	DTID 10003 "Irradiation Event X-ray Data"	See table TID 10003
>	CONTAINS	TEXT	EV (121106, DCM, Comment	"Dose Report"
>	CONTAINS	INCLUDE	DTID 1010 "Person Participant"	Person Procedure Role = EV (113850, DCM, "Irradiation Authorizing") (0032,1032) Requesting Physician (provided by DICOM Worklist)
>	CONTAINS	CODE	EV (113854, DCM, "Source of Dose Information")	113858, DCM, "MPPS Content" or 113856, DCM, "Automated Data Collection" SW 7.08.1 and above: 113856, DCM, "Automated Data Collection"

Table TID 1002. Observer Context

NL	Rel with Parent	VT	Concept Name	Req Type	Condition	Value Set Constraint
	HAS OBS CONTEXT	CODE	EV (121005, DCM, "Observer Type")	MC	IF Observer type is device	If Performing Physician's name is available (0008,1050)
	HAS OBS CONTEXT	INCLUDE	DTID 1003 "Person Observer Identifying Attributes"	MC	(121006, DCM, "Person")	See table TID 1003
	HAS OBS CONTEXT	INCLUDE	DTID 1004 "Device Observer Identifying Attributes"	MC	(121007, DCM, "Device")	See table TID 1004

Table TID 1003. Person Observer Identifying Attributes

NL	Rel with Parent	VT	Concept Name	Value Set Constraint
		PNAME	EV (121008, DCM, "Person Observer Name")	Performing Physician's Name (0008,1050)
		TEXT	EV (121009, DCM, "Person Observer's Organization Name")	Institution Name (0008,0080)
		CODE	EV (121010, DCM, "Person Observer's Role in the Organization")	("309343006", "SCT", "Physician")
		CODE	EV (121011, DCM, "Person Observer's Role in this Procedure")	"113851", "DCM", "Irradiation Administering"

Table TID 1004. Device Observer Identifying Attributes

NL	Rel with Parent	VT	Concept Name	Value Set Constraint
		UIDREF	EV (121012, DCM, "Device Observer UID")	Ziehm Root UID + Device Serial Number + Timestamp
		TEXT	EV (121013, DCM, "Device Observer Name")	AE-Title / Station Name of device
		TEXT	EV (121014, DCM, "Device Observer Manufacturer")	Manufacturer (0008,0070)
		TEXT	EV (121015, DCM, "Device Observer Model Name")	Manufacturer's Model Name (0008,1090)
		TEXT	EV (121016, DCM, "Device Observer Serial Number")	Device Serial Number (0018,1000)
		TEXT	EV (110119, DCM, "Station AE Title")	AE-Title of device

Table TID 10002. Accumulated X-ray Dose

NL	Rel with Parent	VT	Concept Name	Condition	Value Set Constraint
		CONTAINER	EV (113702, DCM, "Accumulated X-ray Dose Data")		
>	HAS CONCEPT MOD	CODE	EV (113764, DCM, "Acquisition Plane")		"113622", "DCM", "Single Plane"
>	CONTAINS	INCLUDE	DTID 10004 "Accumulated Fluoroscopy and Acquisition Projection X-ray Dose"	Because procedure reported is: (113704, DCM, "Projection X-ray")	See table TID 10004
>	CONTAINS	INCLUDE	DTID 10007 "Accumulated Total Projection Radiography Dose"	(113704, DCM, "Projection X-ray")	See table TID 10007

Table TID 10003. Irradiation Event X-ray Data

NL	Rel with Parent	VT	Concept Name	Value Set Constraint
		CONTAINER	EV (113706, DCM, "Irradiation Event X-ray Data")	
>	HAS CONCEPT MOD	CODE	EV (113764, DCM, "Acquisition Plane")	"113622", "DCM", "Single Plane"
>	CONTAINS	UIDREF	EV (113769, DCM, "Irradiation Event UID")	Ziehm Root UID + serial number of device + timestamp + index
>	CONTAINS	DATETIME	DT (111526, DCM, "DateTime Started")	Timestamp
>	CONTAINS	CODE	EV (113721, DCM, "Irradiation Event Type")	If image is 3D-Cine: "113613", "DCM", "Rotational Acquisition" If Snapshot or Radiography: "113612", "DCM", "Stepping Acquisition" If VascularBolus: "113611", "DCM", "Stationary Acquisition" All other: "P5-06000", "SRT", "Fluoroscopy"
>	CONTAINS	TEXT	EV (125203, DCM, "Acquisition Protocol")	OrganProgram-Name and Modifier
>	CONTAINS	CODE	EV (123014, DCM, "Target Region")	Unknown, SRT, unknown
>	CONTAINS	NUM	EV (122130, DCM, "Dose Area Product")	UNITS = EV (Gy.m2, UCUM, "Gy.m2")
>	CONTAINS	TEXT	EV (121106, DCM, "Comment")	
>	CONTAINS	INCLUDE	DTID 10003A "Irradiation Event X-ray Detector Data" DTID 10003B "Irradiation Event X-ray Source Data"	See table 10003AB

Previous software versions including Ziehm 8000 contain only images as Irradiation Events. The classification of the Event Types is new with Software Version 7.08ff.

Table TID 10003AB. Irradiation Event X-ray Detector and Source Data

NL	Rel with Parent	VT	Concept Name	Condition	Value Set Constraint
		IMAGE	EV (113795, DCM, "Acquired Image")	If image object is created for this Irradiation event	SOP Class UID SOP Instance UID = Event UID (if image is not exported to PACS)
		NUM	EV (113738, DCM, "Dose (RP) ")		UNITS = EV (Gy, UCUM, "Gy")
		CODE	EV (113732, DCM, "Fluoro Mode")		"113631", "DCM", "Pulsed" or "113630", "DCM", "Continuous"
		NUM	EV (113791, DCM, "Pulse Rate")	If FluoroMode is (113631, DCM, "Pulsed")	Calculated: NetTime / (GrossTime x PulseWidth) UNITS = EV ({pulse}/s, UCUM, "pulse/s")
		NUM	EV (113768, DCM, "Number of Pulses")	If FluoroMode is (113631, DCM, "Pulsed")	Calculated: PulseRate x GrossTime UNITS = EV (1, UCUM, "no units")
		NUM	EV (113793, DCM, "Pulse Width")		UNITS = EV (ms, UCUM, "ms")

NL	Rel with Parent	VT	Concept Name	Condition	Value Set Constraint
		NUM	EV (113742, DCM, "Irradiation Duration")		GrossTime in UNITS = EV (s, UCUM, "s")
		NUM	EV (113733, DCM, "KVP")		UNITS = EV (kV, UCUM, "kV")
		NUM	EV (113734, DCM, "X-ray Tube Current")		UNITS = EV (mA, UCUM, "mA")
		NUM	EV (113824, DCM, "Exposure Time")		NetTime in UNITS = EV (ms, UCUM, "ms")

Table TID 10004. Accumulated Fluoroscopy and Acquisition Projection X-Ray

NL	Rel with Parent	VT	Concept Name	Condition	Value Set Constraint
		NUM	EV (113726, DCM, "Fluoro Dose Area Product Total")	Sum of all Dose Area Products of EventType Fluoroscopy	UNITS = EV (Gy.m2, UCUM, "Gy.m2")
		NUM	EV (113728, DCM, "Fluoro Dose (RP) Total")	Sum of all Dose(RP) of EventType Fluoroscopy	UNITS = EV (Gy, UCUM, "Gy")
		NUM	EV (113730, DCM, "Total Fluoro Time")	Sum of all Irradiation Durations of EventType Fluoroscopy	UNITS = EV (s, UCUM, "s")
		NUM	EV (113727, DCM, "Acquisition Dose Area Product Total")	Sum of all Dose Area products of EventTypes Acquisition	UNITS = EV (Gy.m2, UCUM, "Gy.m2")
		NUM	EV (113729, DCM, "Acquisition Dose (RP) Total")	Sum of all Dose(RP) of EventTypes Acquisition	UNITS = EV (Gy, UCUM, "Gy")
		NUM	EV (113855, DCM, "Total Acquisition Time")	Sum of all Irradiation Durations of EventTypes Acquisition	UNITS = EV (s, UCUM, "s")

Previous software versions do not distinguish between Fluoroscopy and Acquisition Irradiation event types, therefore Total Time of Fluoroscopy is set to GrossTime Total and Total Time of Acquisition is set to NetTime Total .

Table TID 10007. Accumulated Total Projection Radiography Dose

NL	Rel with Parent	VT	Concept Name	Condition	Value Set Constraint
		NUM	EV (113722, DCM, "Dose Area Product Total")	Sum of Fluoro and Acquisition Dose Area Product Total	UNITS = EV (Gy.m2, UCUM, "Gy.m2")
		NUM	EV (113725, DCM, "Dose (RP) Total")	Sum of Fluoro and Acquisition Dose (RP) Total	UNITS = EV (Gy, UCUM, "Gy")
		NUM	EV (113737, DCM, "Distance Source to Reference Point")	SW 7.08 and above	UNITS = EV (mm, UCUM, "mm")
		CODE	EV (113780, DCM, "Reference Point Definition")		"113861", "DCM", "30 cm in Front of Image Input Surface"

Table A.7.1-43
Display Shutter

Attributes Name	Tag	VR	Value	Presence of Value	Source
Shutter Presentation Value	(0018,1622)	US	0	ANAP	AUTO
Shutter Shape	(0018,1602)	CS	RECTANGULAR	ANAP	AUTO
Shutter Left Vertical Edge	(0018,1604)	IS		ANAP	AUTO
Shutter Right Vertical Edge	(0018,1606)	IS		ANAP	AUTO
Shutter Upper Horizontal Edge	(0018,1608)	IS			
Shutter Lower Horizontal Edge	(0018,0033)	IS		ANAP	AUTO

A.7.1.1.8.1 Attributes of DICOMDIR

Table A.7.1-32

Attributes Name	Tag	VR	Value/Examples	Description
File Meta Information Version	0002,0001	OB	1	Constant
Media Storage SOP Class UID	0002,0002	UI	1.2.840.10008.1.3.10	Constant
Media Storage SOP Instance UID	0002,0003	UI	2.16.840.1.113669.632.6.1.22 00.20030514.4101500.x0	constant, x=2 floppy, x=3 MOD/Stick, x=4 CD
Transfer Syntax UID	0002,0010	UI	1.2.840.10008.1.2.1	Constant
Implementation Class UID	0002,0012	UI	see A.3.2.1.2.4	Constant
Implementation Version Name	0002,0013	SH	see A.3.2.1.2.4	Constant
Source Application Entity Title	0002,0016	AE	Ziehm NetPort AE	user defined
File Set ID	0004,1130	CS	NETPORT_F<serial number>	automatically generated
File Set Consistency Flag	0004,1212	US	0x0000	Constant
Directory Record Type	0004,1430	CS	PATIENT, STUDY, SERIES, IMAGE	Constant
Referenced FileID	0004,1500	CS	XA00001 or XA\XA00001	Filename on medium
Referenced SOP Class UID In File	0004,1510	UI	1.2.840.10008.5.1.4.1.1.7	SOP Class UID
Referenced SOP Instance UID In File	0004,1520	UI	2.16.840.1.113669.632.6.1.22 00.20030514.1101502.11	SOP Instance UID
Patient's Name	0010,0010	PN	Doe^John^^	user supplied
Patient ID	0010,0020	LO	51	user supplied
Patient's Birth Date	0010,0030	DA	19400101	user supplied
Patient's Sex	0010,0040	CS	M	user supplied
Study Date	0008,0020	DA	20030514	Date of patient folder
Study Time	0008,0030	TM	100200	Time of patient folder
Study Description	0008,1030	LO	right hand thumb	user supplied
Study Instance UID	0020,000D	UI	2.16.840.1.113669.632.6.1.22 00.20020514.11002000	generated automatically or supplied by MWL
Study ID	0020,0010	SH	Requested Proc. Step ID	generated automatically or supplied by MWL
Modality	0008,0060	CS	XA,CR,OT,RF,RT,RG	Constant
Series Instance UID	0020,000E	UI	2.16.840.1.113669.632.6.1.22 00.20030514.1100200.10	
Series Number	0020,0011	IS	100000	Number of patient folder
Series Date	0008,0021	DA	20030415	Date of Patient Folder
Series Description	0008,103E	LO	Right hand thumb	user supplied
Image Type	0008,0008	CS	see Table A.7.1-17	
Image Date	0008,0023	DA	20030514	Image Date
Image Time	0008,0033	TM	101502	Image Time
Image Number	0020,0013	CS	11	Constant

A.7.1.1.8.2 Example README.TXT (Vision until SW 5.30)

Institution:

This disk was created by:
<Institution Name>

Media Creator Application:

This disk was created using:
dcmtdk - 3.5.4
(for the DICOMDIR and DICOM files)
MKISOFS ISO 9660/HFS FILESYSTEM BUILDER & CDRECORD CD-R/DVD CREATOR (C)
1993 E.YOUNGDALE (C) 1997 J.PEARSON/J.SCHILLING
(for burning CDs)
Vision Software 5.0.5 10.02.2006
and a manual process.

Contact Information:

If you have any questions about how this disk or the data on it were generated, please contact:

Ziehm Imaging GmbH
Donaustr. 31
D-90451 Nuernberg
ph: +49-911-2172-500
email: service@ziehm.com
Web: www.ziehm.com

Media Organization:

Dicom images are located in folders named XA, CR, OT, RT, RG, RF.

With SW 6.00ff the images are located in subfolders named
<PatientName><StudyDate><folderNumber>

Storage Commitment Request N-ACTION Information

Table A.7.1-33

Attributes Name	Tag	VR	Value	Description
Requested SOP Class UID	0000,1001	UI	1.2.840.1008.1.20.1.1	constant
Action Type ID	0000,1008	US	1	constant
Transaction UID	0008,1195	UI	2.16.840.1.113669.63 2.6.1.1621.20030515. 31258340	constructed from: Ziehm ROOT.UID. <serialNo>.<date>. <time>
Referenced SOP Sequence	0008,1199	SQ		
Referenced SOP Class UID	>0008,1150	UI	1.2.840.5.1.4.1.1.12.1	Selected Storage SOP Class
Referenced SOP Instance UID	>0008,1155	UI	=(0008,0018)	

A.7.2 DATA DICTIONARY OF PRIVATE ATTRIBUTES (for Vario 3D)

The Private Attributes added to created SOP Instances are listed in the table below:

Table A.7.1-34

PRIVATE APPLICATION MODULE ATTRIBUTES

Attributes Name	Tag	VR	Value	Presence of Value	Source
Private Creator	(0029,0010)		ZiehmGroup29	ALWAYS	AUTO
Transformation Info	(0029,10ff)	SQ		ALWAYS	AUTO
>Transformation Matrix BKS to Iso	(0029,1000)	LT	104.704114/...	ALWAYS	AUTO
>Transformation Vector Iso to source	(0029,1001)	LT	0.729651/...	ALWAYS	AUTO
>Transformation Vector Iso to source calibrated	(0029,1002)	LT	0.12/...	ALWAYS	AUTO
>Transformation Matrix Iso to FD	(0029,1003)	LT	31.69328/..	ALWAYS	AUTO
>Transformation Matrix Iso to calibrated FD	(0029,1004)	LT	49.35753/...	ALWAYS	AUTO
>Patient Orientation	(0029,1005)	LT	[L/T]	ALWAYS	AUTO
>scan settings	(0029,1006)	LT	[Adult.MKG.Bone3D]	ALWAYS	AUTO

A.7.3 DATA DICTIONARY OF PRIVATE ATTRIBUTES (as from SW 6.04)

The Private Attributes added to created XA, RF, CR, OT, RT, CT SOP Instances are listed in the table below:

Table A.7.1-45

Attributes Name	Tag	VR	Value (example)
ZIEHM_1.0	(0019,0010)	LO	Private Creator: DeviceConfig
ZIEHM_DeviceConfigData_manufacturer	(0019,1001)	LO	Ziehm Imaging
ZIEHM_DeviceConfigData_modelName	(0019,1002)	LO	Ziehm Vision
ZIEHM_DeviceConfigData_deviceSerialNumber	(0019,1003)	LO	20211
ZIEHM_DeviceConfigData_softwareVersion	(0019,1004)	LO	6.00.1
ZIEHM_DeviceConfigData_retrieveAETitle	(0019,1005)	LO	CBOGEN
ZIEHM_DeviceConfigData_radiationMode	(0019,1006)	LO	PULSED
ZIEHM_DeviceConfigData_typeOfFilters	(0019,1007)	LO	see 0018,1161 ROUND
ZIEHM_DeviceConfigData_fieldOfViewShape	(0019,1008)	LO	POLYGONAL
ZIEHM_DeviceConfigData_collimatorShape	(0019,1009)	LO	--
ZIEHM_DeviceConfigData_centerOfColl	(0019,100A)	LO	--
ZIEHM_DeviceConfigData_radiusOfCircColl	(0019,100B)	LO	--
ZIEHM_DeviceConfigData_collLeftVertEdge	(0019,100C)	LO	--
ZIEHM_DeviceConfigData_collRightVertEdge	(0019,100D)	LO	--
ZIEHM_DeviceConfigData_collUpperHorEdge	(0019,100E)	LT	--
ZIEHM_DeviceConfigData_collLowerHorEdge	(0019,100F)	LO	1024\0\...
ZIEHM_DeviceConfigData_verticesOfPolygonColl	(0019,1010)	LO	
ZIEHM_DeviceConfigData_sourceAxisDistance	(0019,1011)	LO	1100
ZIEHM_DeviceConfigData_distanceSourceToDetector	(0019,1012)	LO	--
ZIEHM_DeviceConfigData_gantryAngle	(0019,1013)	LO	0.2976\0.2976
ZIEHM_DeviceConfigData_imagePlanePixelSpacing	(0019,1014)	LO	Without Magmode
ZIEHM_1.0	(0019,0011)	LO	Private Creator Frame Info

Attributes Name	Tag	VR	Value (example)
ZIEHM_FrameInfo_displayId	(0019,1101)	LO	1
ZIEHM_FrameInfo_isProtected	(0019,1103)	LO	is protected
ZIEHM_FrameInfo_externalDicomTags	(0019,1104)	LT	special tags of RFD 3D
ZIEHM_FrameInfo_kV	(0019,1109)	LO	KV
ZIEHM_FrameInfo_mA	(0019,110A)	LO	mA
ZIEHM_FrameInfo_pulseWidth	(0019,110B)	LO	pulse width
ZIEHM_FrameInfo_aAxisDegrees	(0019,110C)	LO	A Axis degrees
ZIEHM_FrameInfo_cAxisDegrees	(0019,110D)	LO	C Axis degrees
ZIEHM_FrameInfo_yAxisMillimeters	(0019,110E)	LO	Y Axis millimeter
ZIEHM_FrameInfo_zAxisMillimeters	(0019,110F)	LO	Z Axis millimeter
ZIEHM_1.0	(0019,0012)	LO	Private Creator: ImageCaptureDate
ZIEHM_ImageCaptureData_aprName	(0019,1200)	LO	Apr Name i.e.Bone
ZIEHM_ImageCaptureData_aprModifier	(0019,1201)	LO	Apr Modifier
ZIEHM_ImageCaptureData_aprMetalMode	(0019,1202)	LO	i.e.Fluoro
ZIEHM_ImageCaptureData_aprRepositionMode	(0019,1203)	LO	True or False
ZIEHM_ImageCaptureData_kV	(0019,1204)	LO	75 kV
ZIEHM_ImageCaptureData_mA	(0019,1205)	LO	3.1 mA
ZIEHM_ImageCaptureData_pulseWidth	(0019,1206)	LO	0:00:00.030
ZIEHM_ImageCaptureData_frameRate	(0019,1207)	LO	15 Hz
ZIEHM_ImageCaptureData_burstsPerFrame	(0019,1208)	LO	1
ZIEHM_ImageCaptureData_noiseReductionLive	(0019,1209)	LO	2
ZIEHM_ImageCaptureData_noiseReductionLIH	(0019,120A)	LO	4
ZIEHM_ImageCaptureData_captDevType	(0019,120B)	LO	FLAT
ZIEHM_ImageCaptureData_captDevMagMode	(0019,120C)	LO	NoImgMag
ZIEHM_ImageCaptureData_isBlankingMaskActive	(0019,120D)	LO	False
ZIEHM_ImageCaptureData_CO2	(0019,120E)	LO	False
ZIEHM_ImageCaptureData_imageAreaDoseProduct	(0019,1210)	LO	1.57... cGycm2
ZIEHM_ImageCaptureData_exposureTimeNet	(0019,1211)	LO	0:00:01.001
ZIEHM_ImageCaptureData_exposureTimeGross	(0019,1212)	LO	0:00:03:333
ZIEHM_ImageCaptureData_detectorElementSpacing	(0019,1213)	LO	Includes MagMode
ZIEHM_ImageCaptureData_ZAIP2FiltersAreIncluded	(0019,1214)	LT	
ZIEHM_ImageCaptureData_autoCroppingShape	(0019,1215)	LO	
ZIEHM_ImageCaptureData_DIN_DSA	(0019,1216)	LO	
ZIEHM_ImageCaptureData_gridPresent	(0019,1217)	LO	
ZIEHM_ImageCaptureData_captDevTypeAltConfig	(0019,1218)	LO	
ZIEHM_ImageCaptureData_fipFilterInformation	(0019,1219)	LO	
ZIEHM_1.0	(0019,0013)	LO	Private Creator: ImageDisplayData
ZIEHM_ImageDisplayData_angle	(0019,1300)	LO	171 °
ZIEHM_ImageDisplayData_angleBase	(0019,1316)	LO	0 °
ZIEHM_ImageDisplayData_isMirroredLR	(0019,1301)	LO	False
ZIEHM_ImageDisplayData_isMirroredUD	(0019,1302)	LO	False
ZIEHM_ImageDisplayData_digitalZoomBase	(0019,1315)	LO	1
ZIEHM_ImageDisplayData_zoomFactor	(0019,1303)	LO	1
ZIEHM_ImageDisplayData_pixelShiftX	(0019,1304)	LO	0
ZIEHM_ImageDisplayData_pixelShiftY	(0019,1305)	LO	0
ZIEHM_ImageDisplayData_edgeEnhancement	(0019,1306)	LO	0
ZIEHM_ImageDisplayData_windowingWindow	(0019,1307)	LO	1
ZIEHM_ImageDisplayData_windowingLevel	(0019,1308)	LO	0.5
ZIEHM_ImageDisplayData_isInverted	(0019,1309)	LO	False
ZIEHM_ImageDisplayData_landmarkingPortion	(0019,130A)	LO	0
ZIEHM_ImageDisplayData_horCrop	(0019,130B)	LO	0
ZIEHM_ImageDisplayData_vertCrop	(0019,130C)	LO	0
ZIEHM_ImageDisplayData_shutterShape	(0019,130D)	LO	RECTANGULAR
ZIEHM_ImageDisplayData_centerOfShutter	(0019,130E)	LO	--
ZIEHM_ImageDisplayData_radiusOfCircShutter	(0019,130F)	LO	--
ZIEHM_ImageDisplayData_shutterLeftVertEdge	(0019,1310)	LO	--
ZIEHM_ImageDisplayData_shutterRightVertEdge	(0019,1311)	LO	--

Attributes Name	Tag	VR	Value (example)
ZIEHM_ImageDisplayData_shutterUpperHorEdge	(0019,1312)	LO	--
ZIEHM_ImageDisplayData_shutterLowerHorEdge	(0019,1313)	LO	--
ZIEHM_ImageDisplayData_verticesOfPolygonShutter	(0019,1314)	LT	--
ZIEHM_1.0	(0019,0014)	LO	Private Creator: ImageData
ZIEHM_ImageData_instanceUID	(0019,1404)	LO	<SOP Instance UID>
ZIEHM_ImageData_imageType	(0019,1405)	LO	Single
ZIEHM_ImageData_displayId	(0019,1406)	LO	1
ZIEHM_ImageData_comments	(0019,1407)	LO	--
ZIEHM_ImageData_numPixelsX	(0019,1408)	LO	1024
ZIEHM_ImageData_numPixelsY	(0019,1409)	LO	1024
ZIEHM_ImageData_numGrayscales	(0019,140A)	LO	1024
ZIEHM_ImageData_isProtected	(0019,140C)	LO	False
ZIEHM_ImageData_isCineMaskOn	(0019,140D)	LO	False
ZIEHM_ImageData_cineMaskDisplayId	(0019,1411)	LO	0
ZIEHM_ImageData_cineStartDisplayId	(0019,1412)	LO	0
ZIEHM_ImageData_cineStopDisplayId	(0019,1413)	LO	0
ZIEHM_ImageData_dicomStatus	(0019,1414)	LO	None
ZIEHM_ImageData_externalDicomTags	(0019,1415)	LO	--
ZIEHM_ImageData_captureDate	(0019,1416)	LO	2012-08-01
ZIEHM_ImageData_captureTime	(0019,1417)	LO	10:04:33.133
ZIEHM_ImageData_modificationDate	(0019,1418)	LO	2012-08-07
ZIEHM_ImageData_modificationTime	(0019,1419)	LO	13:21:00.107
ZIEHM_ImageData_smartAnnotations	(0019,141E)	LO	
ZIEHM_ImageData_aquisitionDate	(0019,141F)	LO	
ZIEHM_ImageData_aquisitionTime	(0019,1420)	LO	
ZIEHM_1.0	(0019,0015)	LO	Private Creator: PatientData
ZIEHM_PatientData_patientID	(0019,1502)	LO	PAT123
ZIEHM_PatientData_namePrefix	(0019,1503)	LO	-- until 7.03/7.05
ZIEHM_PatientData_givenName	(0019,1504)	LO	-- until 7.03/7.05
ZIEHM_PatientData_middleName	(0019,1505)	LO	John until 7.03/7.05
ZIEHM_PatientData_familyName	(0019,1506)	LO	Doe until 7.03/7.05
ZIEHM_PatientData_nameSuffix	(0019,1507)	LO	• until 7.03/7.05
ZIEHM_PatientData_birthDate	(0019,1508)	LO	1999-01-01
ZIEHM_PatientData_sex	(0019,1509)	LO	M
ZIEHM_PatientData_name	(0019,1512)	LO	3 component name
ZIEHM_1.0	(0019,0016)	LO	Private Creator: PhysicianData
ZIEHM_PhysicianData_namePrefix	(0019,1601)	LO	Dr. – until 7.03/7.05
ZIEHM_PhysicianData_givenName	(0019,1602)	LO	Eva until 7.03/7.05
ZIEHM_PhysicianData_middleName	(0019,1603)	LO	• until 7.03/7.05
ZIEHM_PhysicianData_familyName	(0019,1604)	LO	Miller until 7.03/7.05
ZIEHM_PhysicianData_nameSuffix	(0019,1605)	LO	• until 7.03/7.05
ZIEHM_PhysicianData_name	(0019,1606)	LO	3 component name
ZIEHM_1.0	(0019,0017)	LO	Private Creator: SeriesData
ZIEHM_SeriesData_creationDate	(0019,1717)	LO	2012-08-01
ZIEHM_SeriesData_creationTime	(0019,1718)	LO	10:00:00.000
ZIEHM_SeriesData_instanceUID	(0019,1704)	LO	<Series Instance UID>
ZIEHM_SeriesData_description	(0019,1705)	LO	--
ZIEHM_SeriesData_departmentName	(0019,1706)	LO	TestDepartment
ZIEHM_SeriesData_modality	(0019,1707)	LO	XA
ZIEHM_SeriesData_perfStationAETitle	(0019,1708)	LO	--
ZIEHM_SeriesData_perfProcStepID	(0019,1709)	LO	--
ZIEHM_SeriesData_perfProcStepStartTime	(0019,170A)	LO	2012-08-01 10:00
ZIEHM_SeriesData_perfProcStepLocation	(0019,170B)	LO	--
ZIEHM_SeriesData_perfProcStepStatus	(0019,170C)	LO	IN PROGRESS

Attributes Name	Tag	VR	Value (example)
ZIEHM_SeriesData_perfProcInstanceUID	(0019,170D)	LO	<MPPS Instance UID>
ZIEHM_SeriesData_schedProcStepID	(0019,170E)	LO	123
ZIEHM_SeriesData_schedProcStepDescr	(0019,170F)	LO	--
ZIEHM_SeriesData_protocolName	(0019,1710)	LO	--
ZIEHM_SeriesData_seriesNumber	(0019,1716)	LO	1
ZIEHM_1.0	(0019,0018)	LO	Private Creator: StudyData
ZIEHM_StudyData_instanceUID	(0019,1803)	LO	<Study Instance UID>
ZIEHM_StudyData_creationDate	(0019,1819)	LO	
ZIEHM_StudyData_creationTime	(0019,181A)	LO	2012-08-01
ZIEHM_StudyData_description	(0019,1807)	LO	10:00:00:0.00
ZIEHM_StudyData_institutionName	(0019,1808)	LO	--
ZIEHM_StudyData_accessionNr	(0019,1809)	LO	TestHospital
ZIEHM_StudyData_reqProcID	(0019,180A)	LO	123
ZIEHM_StudyData_reqProcDescr	(0019,180B)	LO	--
ZIEHM_StudyData_refStudySopClassUID	(0019,180C)	LO	---
ZIEHM_StudyData_refStudySopInstanceUID	(0019,180D)	LO	--
ZIEHM_StudyData_imageAreaDoseProduct	(0019,180E)	LO	--
ZIEHM_StudyData_totalNumOfExposures	(0019,180F)	LO	308.532 cGycm2
ZIEHM_StudyData_sumExposureTimeNet	(0019,181B)	LO	68
ZIEHM_StudyData_sumExposureTimeGross	(0019,181C)	LO	0:05:22.998
ZIEHM_StudyData_sumFramesExposed	(0019,181D)	LO	0:15:22.000
ZIEHM_StudyData_sumFramesTotal	(0019,181E)	LO	
ZIEHM_StudyData_sumKerma	(0019,1813)	LO	
ZIEHM_StudyData_nextDisplayId	(0019,1814)	LO	23.2 mGy
ZIEHM_StudyData_isProtected	(0019,1816)	LO	2
ZIEHM_StudyData_ESWL_StartTime 1	(0019,181f)	LO	False
ZIEHM_StudyData_ESWL_EndTime 1	(0019,1820)	LO	
ZIEHM_StudyData_ESWL_Shocks	(0019,1821)	LO	
ZIEHM_StudyData_ESWL_SML_I 1	(0019,1822)	LO	
ZIEHM_StudyData_ESWL_EnergyLeve	(0019,1823)	LO	
ZIEHM_StudyData_ESWL_Focus	(0019,1824)	LO	
ZIEHM_StudyData_ESWL_Note 1	(0019,1825)	LO	
ZIEHM_StudyData_reasonForReqProc	(0019,1826)	LO	
ZIEHM_StudyData_institutionAddress	(0019,1827)	ST	
Ziehm_1.0	(0021,0010)	LO	Private Creator: Special Tags
ZIEHM_SpecialTags_Mosaic	(0021,1000)	OW	<pixel data of mosaic>
ZIEHM_SpecialTags_Overlay	(0021,1001)	LT	
ZIEHM_SpecialTags_Format	(0021,1002)	LO	<Overlay data>
ZIEHM_SpecialTags_PerformedProcedureCode	(0021,1003)	SQ	ZIEHM_BACKUP
ZIEHM_SpecialTags_RequestedProcedureCode	(0021,1004)	SQ	--
ZIEHM_SpecialTags_DataInPicture	(0021,1005)	OB	--
ZIEHM_SpecialTags_DataInPictureSeq	(0021,1006)	SQ	00/00/...

A.7.3.1 Private Tags provided by RFD 3D

Table A.7.1-44

PRIVATE APPLICATION MODULE ATTRIBUTES

Attributes Name	Tag	VR	Value	Presence of Value	Source
Private Creator	(0029,0010)	LO	Ziehm_1.0	ALWAYS	AUTO
Transformation Info	(0029,10ff)	SQ	For ISO-Cine	ALWAYS	AUTO
>Transformation Matrix BKS to Iso	(0029,1000)	LT	104.704114/...	ALWAYS	AUTO
>Transformation Vector Iso to source	(0029,1001)	LT	0.729651/...	ALWAYS	AUTO
>Transformation Vector Iso to source calibrated	(0029,1002)	LT	0.12/...	ALWAYS	AUTO
>Transformation Matrix Iso to FD	(0029,1003)	LT	31.69328/..	ALWAYS	AUTO
>Transformation Matrix Iso to calibrated FD	(0029,1004)	LT	49.35753/...	ALWAYS	AUTO
>Patient Orientation	(0029,1005)	LT	[R\H]	ALWAYS	AUTO
>Body Region	(0029,1006)	LT	[Child.HandRight.Bone3D]	ALWAYS	AUTO
>Frame Valid Flag	(0029,1007)	LT	1	ALWAYS	AUTO
>Field of View Mode	(0029,1008)	LT	0	ALWAYS	AUTO
>Detector	(0029,1009)	LT	[FPD_12in_Fuji]	ALWAYS	AUTO
>Panel Mode	(0029,1010)	LT	1	ALWAYS	AUTO
>Grid missing	(0029,1011)	LT	0	ALWAYS	AUTO
Private Creator	(0029,0020)	LO	Navigation	ANAP	AUTO
Transformation Fluoro kit to Volume	(0029,2004)	LO	for Brainlab Navi	ANAP in MPR for Navi	AUTO
Trajectory Information	(0029,2010)	LT	[T2]	ANAP in MPR	AUTO
Private Creator	(0029,0030)	LO	Body Region	ANAP in MPR	AUTO
Body Region	(0029,3001)	LT	[Child.HandRight.Bone3D]	ANAP in MPR	AUTO
Private Creator	(0029,0040)	LO	Internal 3D image data in first MPR slice	ANAP	AUTO
Character field	(0029,4001)	UT		VNAP	AUTO

A.7.4 ZIEHM NAVIPOINT 2D

The Ziehm NaviPort 2D has been created in the Year 2003.

A.7.4.1 Configuration

The configuration is described in A.3.4.1.2.1 Table A.3.4-3.

A.7.4.2 Navigation Flag

Ziehm Vision: switch on Navigation in dialog Config Operation Settings

Others: set Function to Navigation in dialog DICOM Settings Print Server

A.7.4.3 Behavior

If navigation is on, the C-arm sends two UDP messages to the configured navigation server at port 56666, the first after X-ray-off, the second at the end of stack filter.

Pressing STORE at the mobile stand, the image will be sent by DICOM Store to the navigation server.

The corresponding image archives the date and time of the UDP messages into the DICOM tags

Content Date (0008,0023) and Content Time (0008,0033) (Vision: net_navImage = 2)

and Study Date (0008,0020) and Study Time (0008,0030) (Vision: net_naviStudy = 2)

Only single images without image attributes are stored.

With SW 6.00ff the name convention is obsolete.

A.7.4.4 Form of UDP messages

<AETitle Ziehm NetPort>;<SW-Version>;<No of stack filter>;<No of message>;<date>;<time>;

i.e: first message: ZiehmNP-F2526;21.000;4;1;20060930;120411;

second message: ZiehmNP-F2526;21.000;4;2;20060930;120411;

A.8 IHE INTEGRATION STATEMENT

IHE Integration Statement		Date: 08.08.2018
Vendor	Product Name	Version
Ziehm Imaging GmbH	Ziehm Vision	3.0
This product implements all transactions required in the IHE Technical Framework to support the IHE Integration Profiles, Actors and Options listed below: domain: Radiology		
Integration Profiles Implemented	Actors Implemented	Options Implemented
Scheduled Workflow (SWF)	Acquisition Modality	
Patient Information Reconciliation (PIR)	Acquisition Modality	
Radiation Exposure Monitoring (REM)	Acquisition Modality	
Consistent Time (CT)	Time Client	
Internet address for vendor's IHE information : www.ziehm.com		
Links to Standards Conformance Statements for the implementation		
Links to general information on IHE		
In North America : www.ihe.net	In Europe : www.ihe-europe.org	In Japan : www.ihe-j.org

